



.....

· **Domestic Heat Pumps** · · · · ·

· A Best Practice Guide · · · · ·

.....

.....

.....

.....

.....

.....

.....

.....



Introduction

The number of heat pumps installed in the UK has increased significantly over the past few years with around 20,000¹ domestic heat pumps installed every year. This is expected to increase further due to rising fuel costs, government policy and the shift towards a more decarbonised grid. Therefore the potential market for heat pumps is huge.

However, for heat pumps to reach their full potential it is vitally important that end users, particularly householders can make an informed choice and have confidence that once installed their system will deliver on any benefits claimed in the contract.

From an installation point of view, this can be achieved by applying best practice throughout the whole customer journey. From pre-sales, design and installation to commissioning and handover.

As an installer, this MCS Best Practice Heat Pump Guide aims to assist you with all of these stages.

This guide has been developed and written with the support of the following organisations, with input from the MCS Heat Pump Working Group (No 6) who subsequently approved the guide:

- Energy Saving Trust
- Heat Pump Association (HPA)
- Renewable Energy Consumer Code (RECC)

MCS would also like to thank the organisations above for contributing towards the funding of the guide.

Scope and purpose

The purpose of this MCS Best Practice Heat Pump Guide is to support designers and installers of domestic scale heat pumps in the selection, installation and commissioning of such heat pumps, including smaller commercial scale, to ensure optimum performance for all parties involved but especially the consumer. It also tries to improve the interface between installer and consumer in encouraging information flow such as performance estimates and the implications of consumer law.

MCS intends to issue specific advice for consumers as a separate document.

Consequently this guide primarily focuses on domestic scale heat pumps up to 45 kW including:

- Air source
- Ground source
- Exhaust air

But also touches on those that are less established, including:

- Gas absorption
- Gas engine
- Thermodynamic/solar assisted
- Heat recovery

¹ Based on figures provided by the Heat Pump Association. Less than half of these are MCS registered meaning thousands are installed outside the 'protection' of MCS reinforcing the need to develop this guide.

How to use this guide

This guide should be used in conjunction with the latest version of the MCS Microgeneration Installation Standard: MIS 3005 V5.0. It consists of three key parts:

Part 1

Technical Guidance:
Getting the design & installation right

Part 2

The Contractual Issues:
Getting the contract right

Part 3

Specific Guidance on MIS 3005 V5.0
(forming MGD 002 Issue 2)

Heat pump installers should consult these parts for specific best practice advice. The contractual issues explored in Part 2 are described within the context of heat pumps.

The case studies, examples and tips used in this part should help clarify most of the issues a heat pump installer could encounter when dealing with consumers.

Each chapter within Parts 1 and 2 contains both a short summary of the key points followed by more in-depth details. There is also a part at the end with guidance on specific MIS 3005 clauses and associated documents.

Health and Safety

The installation, operation and maintenance of heat pump systems do not normally present excessive health and safety requirements and should normally have a low/medium risk. However, notice should be taken for the following with standard protocols adopted:

- **Electrical supplies** - care should be taken with any appliance that utilises electricity in any way and should only be installed and serviced by a competent electrician.
- **Working at height** - due care should be taken when working at height.
- **Working below ground level** - due care should be taken not to enter any excavations below ground level without adequate protection, e.g. such as temporary or permanent shoring of the sides of the excavation. *All services below ground and especially electric cables should have appropriate identification tapes buried above the service to adequately warn the operator during any future excavation.*
- **Working in confined spaces** - due care should be taken when working in confined spaces such as small plant-rooms, lofts or under-floors.
- **Chemicals** - all chemicals used, such as water treatment, biocides, anti-freeze etc. should be handled according to the manufacturers/suppliers instructions and with due caution.
- **High pressure systems** - warning notices should be provided at all points where pressure relief valves discharge. Heat pumps rarely require the high pressure refrigerant circuit to be disturbed, however, if required, servicing should **ONLY** be carried out by a correctly certified person and in most cases this will be a legal requirement for the handling of 'F' Gas refrigerants.
- **Specialist works** - such as working on or near major water courses, lakes, rivers, canals etc. should have specific risk assessments carried out by competent personnel.

Installers should also be familiar with all relevant health and safety legal requirements and information from responsible bodies such as the Health and Safety Executive, Control of Substances Hazardous to Health (COSHH) regulations and general electrical safety.

If you have any suggestions for updates or amends to this Guide, please email:
meetings@mcscertified.com

contents

Introduction	01
Scope and purpose	01
How to use this guide	02
Health and safety	03
Part 1 – Technical Considerations – Getting the design and installation right	05
1.0 – Technical Introduction	06
2.0 – Choosing a Heat Pump system	07
3.0 – Sizing the Heat Pump	12
4.0 – Selecting and Sizing Heat Emitters	16
5.0 – Systems Design and Pipework Sizing	19
6.0 – Controls Options	23
7.0 – Optimising Unit & System Efficiency	28
8.0 – Installation and Commissioning Advice	32
9.0 – Operating Advice	33
10.0 – Maintenance Advice	34
11.0 – Specific Requirements of Heat Pump Units and Systems	35
Part 2 – Contractual Issues – Getting the contract right	39
1.0 – Introduction	40
2.0 – Consumer Journey Options	41
3.0 – The Right to Cancel	48
4.0 – The information you must provide	53
5.0 – The information you choose to provide	58
6.0 – Unfair Contracts	66
7.0 – Unacceptable terms in microgeneration contracts	70
8.0 – Goods and services, including installation – your obligations in law	76
9.0 – Dealing with complaints and disputes	79
Part 3 – A Guide to MIS 3005	84

Best
Practice

Technical Considerations

Getting the design and installation right



1.0 Technical Introduction

This Best Practice Guide endeavours to do just that, suggest best or good practice. It should not be regarded as a design manual in its own right and should be used in conjunction with other guides such as the CIBSE Domestic Heating Design Guide, BRE Design of Low-Temperature Heating Systems, BESA Low Temperature Heating Guide, and various guides issued by the Ground Source Heat Pump Association (GSHPA).

This document does not necessarily represent specific guidance from MCS and is not a commentary on the MCS Installation Standard 3005. Readers attention is drawn to Part 3 of this guide which gives specific guidance on the interpretation of MIS 3005.

2.0 Choosing a Heat Pump System

2.1. General

Heat pumps may take their energy from the air, the ground, or a source of water. This energy is then delivered as heat via a heating or hot water system.

Please note:

End users are often confused by the term ‘hot water’, used to describe the fluid circulated around the closed circuit space heating and domestic hot water system (DHWS) primary heating circuit, as opposed to the actual hot water supply consumed for sanitary purposes. In this document the heating circuits (space heating and hot water primary) will be described as “heated water” and the hot water provided to taps, showers etc will be described as “Domestic Hot Water” or “DHW”.

Table 1: Heat Pump types

Air Source: Air-to-Water (or “A-W”)
Air Source: Air-to-Air (“A-A”)
Ground Source: Closed Loop: Water to water: (W-W)
Ground Source: Open Loop via subterranean aquifer (W-W)
Water Source: Open Loop via surface water (W-W)

2.2. Air Source Heat Pumps (ASHP)

Air Source Heat Pumps (ASHP) extract the heat energy contained within ambient air and upgrades its temperature to a more useful temperature. In that sense it is 'pushing' heat (from low to high temperature) against its natural thermodynamic flow. As the external temperature varies throughout the heating system, the performance of an ASHP will vary considerably over the annual cycle and therefore 'seasonal' efficiencies should be considered.

2.3. Ground Source Heat Pumps (GSHP)

As the term suggests, Ground Source Heat Pumps (GSHP) extract heat stored in the ground, usually via water as the source transfer fluid. There are various methods of doing this, as outlined below.

2.3.1. Closed Loop

In this type of GSHP, pipework is buried in the ground either horizontally, just below the surface (typically 1-2m), or within vertical (or deep penetrating) boreholes.

Closed loop GSHP is the most common form of GSHP because it is easier to predict performance and requires considerably less maintenance than open loop GSHP system boreholes.

Figure 1 (below) demonstrates the change in ground temperature at various depths and seasons. It highlights that there is a delay factor the deeper the depth until approximately 17 meters, where the temperature stabilises.

Figure 1.

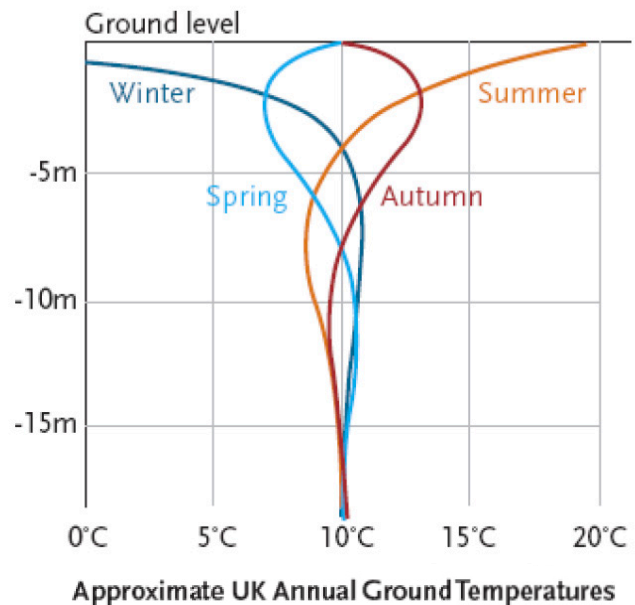

2.3.2. Open Loop: Below Ground and Surface Water

These are specialist systems which are best procured for design and construction with appropriately competent and experienced specialists with commensurate qualifications, experience and professional insurance.

2.3.2.1. Below Ground

Water is abstracted directly from the ground and pumped to the heat pump directly or via a high efficiency water-to-water heat exchanger which can protect the heat pump from corrosion and/or build-up of unwanted matter (e.g. sand, silt, debris, etc.). Usually an aquifer is located within bedrock and tapped into by drilling into the rock.

Typically, the heat pumps used with these systems are described as ‘water source’ heat pumps because they are extracting heat from water within the ground aquifer. They tend to operate at higher temperatures than closed loop ground source heat pumps.

It is worth noting that the pumping energy required to abstract and ‘lift’ the water out of the ground can be quite significant for deep boreholes.

2.3.2.2. Surface Water

Heat is extracted from large surface water reservoirs such as lakes, rivers or the sea. This can be achieved in closed loop or open loop forms.

It is important to note that for all GSHP systems (open or closed loop) the actual heat pump device utilized is a water-to-water (W-W) heat pump designed to operate at temperatures appropriate to the source temperatures.

Please note:

The phrase “brine” is still widely used to refer to the thermal transfer fluid within a closed loop system, due to the fact that salts used to be dissolved into the fluid to prevent freezing. With the advent of modern anti-freeze chemicals (such as Glycol, propylene etc) the correct phrase to use is “Thermal Transfer Fluid” (TTF) which would normally be mostly water based with added anti-freeze and anti-biofouling chemicals (biocides). Throughout this document TTF will be used and implication is that other necessary chemicals are included.

Tip: The GSHPA provide guidance for the design and installation of ground & water source systems and these should be consulted. In addition, in association with the CIBSE and HPA they have produced CIBSE Heat Pump Codes of Practice CP3 and CP2 for ‘Open Loop Groundwater Source Heat Pumps’ and ‘Surface Water Heat Pump Systems’ respectively.

Key point:

The design and installation of ground source systems should be undertaken with care and attention. Open loop systems can present particular challenges and will require the services of a specialist.

2.4. Exhaust Air Heat Pumps (EAHP)

Exhaust Air Heat Pumps extract the heat energy contained within exhaust air; the air exhausted out of a building as part of a ventilation system. This heat is upgraded in temperature to a more useful temperature and is transferred into heated water for space heating, and directly to heat domestic hot water.

This system relies heavily on the presence of heat generated within the space and generally requires a very low heat loss building. (They are not to be confused with air-to-air heat recovery heat pumps (see 2.8 Heat Recovery Heat Pumps (HRHP) on page 11).

2.5. Gas Absorption/Adsorption Heat Pumps (GAHP)

Gas Absorption/Adsorption Heat Pumps use direct heat energy from the combustion of gas (natural or LPG) to effect the absorption or adsorption of a medium into another which creates a low temperature, low pressure side and a high pressure, high temperature side.

The process may be to change the chemical composition (Absorption) or merely mechanically combine two chemicals temporarily together (Adsorption).

Rather than using 'Coefficient of Performance' (CoP), efficiencies for GAHPs are expressed as "Gas Utilisation Efficiency" (GUE). CoP and GUE are not directly comparable as they can ignore primary energy conversion and latent heat respectively. GUE can be stated using either Net or Gross calorific values of the gas.

Earlier British/EN Standards ignored the latent heat of condensation within the gas combustion process and used Net calorific values for efficiency calculations. This tends to artificially inflate the efficiency of this type of heat pump. These figures are sometimes still quoted. However Standards have been revised and under the current Standards (BS EN 12309: Part 4, 2014) the Gross CV figure for gas input must be declared.

GAHPs have two key advantages:

1. They can use the resource of gas (natural or LPG) where the electricity network may be weak (low capacity or frequently interrupted).
2. As a combustion process is still utilised, the flow temperatures of the heating fluid produced can be significantly higher than an electric vapour compression cycle with little or no loss of efficiency. This makes it useful for retro-fit using existing emitters and for generation of domestic hot water without the need for additional pasteurisation.

2.6. Gas Engine Heat Pumps (GEHP)

Gas Engine Heat Pumps are not presently significant in the UK domestic market but have a small presence in the commercial market where heating and cooling are required and particularly where electrical power supplies are limited.

2.7. Solar Assisted (Thermodynamic Panel) Heat Pumps (SAHP)

These devices have entered the UK market after development work in southern Europe. They use a vapour compression cycle to generate heat from a non-aspirated evaporator which should be located externally in the ambient air and is able to benefit from additional heat from direct solar radiation.

It is generally believed these systems are better suited to domestic hot water, however, some also promote these systems for space heating. Such systems are generally small duty.

2.8. Heat Recovery Heat Pumps (HRHP)

Heat Recovery Heat Pumps are ideal to recover heat, particularly low grade heat, and increase its temperature to more useful values. Hence HRHP's recover heat from various sources that would otherwise be wasted.

2.8.1. Air-to-Air

Typically extracts heat from the exhaust air and re-injects this heat into the cold incoming fresh air.

2.8.2. Water-to-Water

Typically used to extract heat from waste, domestic hot water or process hot water and reinject this into the hot water system, usually via the storage vessel.

3.0 Sizing the Heat Pump

3.1. General

Sizing the heat pump correctly is of paramount importance. Various field trials seem to indicate that accurate sizing is important in order to maintain efficient running of the system^{1,2}.

Heat pumps should be selected as closely as possible to the design heat demands. MCS Standard MIS 3005, requires the unit to achieve 100% of the duty at an external temperature condition exceeded for 99.6% of the year, if reasonably practicable. It also stipulates that supplementary heat is not permitted from direct electric at external temperatures above the design external temperature (“bi-valent point” or “balance point”), but other alternative auxiliary sources of heat are permitted where this is not reasonable practicable in which case the system becomes a ‘hybrid’ system.

Although additional supplementary heat may be required when the external temperature drops below the bi-valent/balance point, this will occur for very short periods of the year and therefore does not significantly affect overall seasonal efficiency even when direct electric heat is utilised.

Therefore, heat pumps should be selected as closely as possible to the design demands.

Warning: It has been normal practice with combustion heating systems to use rules of thumb for design. This is not good practice for detailed design (e.g. selecting heat emitters) and final selection of the heat generator and should NEVER be used for this purpose. MIS 3005 follows existing Standards to deliver good practice in design and selection.

Rules of thumb (i.e. W/m^2 or W/m^3 covering all elements) or ‘whole house’ calculations may be used for approximate sizing and overall project feasibility but should NOT be used for the final design and selection of the heating system.

3.2. Heat Loss Calculations

Heat loss calculations for final design and selection purposes should be conducted on an elemental basis, i.e. calculating heat loss through the various elements (walls, roof, windows, floor, ventilation/infiltration etc.) and aggregated together.

MCS provides a freely available heat loss calculator on its website.

¹ EST Field Trial Phase 2 report

² DECC RHPP Field trial report

3.2.1. Fabric Losses

Fabric losses should be calculated according to the latest BS EN 12831 Standard. External design temperatures should reflect typical low temperatures experienced in the winter heating season and as a guide should be exceeded for 99.6% of the year.

The MCS Standard sets out these requirements in more detail (see Part 3 - A Guide to MIS 3005 on page 78).

3.2.2. Heat Losses due to Fresh Air

Fresh air, whether by natural infiltration or mechanical ventilation adds to the heat loss of a building and therefore to the heat demand.

3.2.2.1. Natural Air Infiltration Heat Losses

This is an important area of design and especially so as increased fabric insulation standards increase the proportion this makes up of the total building heat loss. In addition, there are many factors to take into account which rely considerably on assumptions. For instance, the age of the building may not well indicate the loss of heat due to air passing through the structure, because an old house may have had double glazing retrofitted and openings including windows and doors now have rubber gaskets sealing them. Furthermore, the presence of a chimney may significantly increase the air leakage, however if a restrictor is in place this may have a dramatic effect on reducing the air leakage.

It is important that the heating designer takes into consideration the age of the property, its construction and any alterations undertaken. Any calculations should be in accordance with relevant Standards (e.g. BS EN 15831) and industry accepted guidelines (e.g. from the Domestic Heating Compliance guides).

3.2.2.2. Mechanical Ventilation Air Heat Losses

Systems employing mechanical ventilation, for example, lavatory extract systems or supply and extract Mechanical Ventilation with Heat Recovery (MVHR), will also affect the demand for heat (both power and energy).

If a lavatory has a mechanical extraction which is controlled in some way by occupancy, it could be argued that the full instantaneous heat loss during a ventilation cycle need not be met as there will be considerable off periods in order for it to recover. However, if the room is also a bath or shower room it may be less desirable to have long re-heat periods and a greater proportion of the 'worst case' heat loss may need to be considered.

Please note:

Typically air extraction from kitchens and bathroom/WC's occur for relatively short periods of time. So overall, time averaged heat losses are relatively smaller than the instantaneous load. In such areas the operation of the ventilation system is related to activities which themselves introduce additional heat into the spaces (e.g. cooking appliances, baths, showers). Sizing heat emitters in such spaces to fully compensate for intermittent ventilation related heat losses may not be necessary. Furthermore air exhausted from these areas is most likely partially drawn from elsewhere in the building and therefore heat emitters in such adjoining areas could 'share' the load. However, there must be adequate load overall to cope with the heat demand.

Tip: Provide sufficient heat output in each mechanically ventilated space (kitchen, bathroom, WC etc.) to deal with 'static' heat losses (i.e. fabric and natural, unforced or infiltration) and ensure that there is sufficient additional capacity in adjoining rooms to cope with the time weighted additional amount from forced ventilation (extract fans), or additional loss from manual 'additional' ventilation (open windows) to provide the equivalent to forced ventilation.

Please note:

Adjoining rooms MUST have a clear pathway for air transfer to the relevant room, for example, gaps under doors or an opening like a hatch or archway. Adjoining rooms are, for example, the bedroom to which an en-suite is attached, the landing area outside a bathroom, hallway or entrance way to a kitchen.

3.3. Hot Water Demand

A consensus on how to adequately size the heat pump for domestic hot water production does not currently exist. Much will depend on the controls strategy employed. Many heat pumps will be designed to automatically switch between modes (space heating and domestic hot water systems), often on a thirty-minute rotation, when a demand for both services is identified.

Others will continue to deal with the hot water load until either it is met, or a set time has elapsed. The lack of ability to sufficiently heat either the space heating circuit, or hot water storage may initiate internal (or external) direct electric resistance immersion heaters. This will reduce the efficiency of the system overall and therefore should be avoided as far as reasonably practicable.

What is established is that with highly insulated buildings becoming ever more present it is no longer adequate to merely size the heat pump for the space heating requirement. The hot water load becomes more significant with very well insulated properties and particularly with 'Passivhaus' where the domestic hot water load becomes potentially the only load.

The Contractor should consult and familiarise themselves with the latest version of BS EN 16147 to determine loads for domestic hot water production.

The typical consumption pattern should be discussed with the client and they should be advised of the design re-heat time.

Domestic hot water cylinders must have heat exchangers suitable for use with the temperatures and outputs derived from the selected heat pump.

3.4. Heat Pump Capacity

It is essential that a heat pump is selected to achieve the desired output for at least the design conditions, if not slightly more onerous conditions which may not be the same as the nominal rating of the unit. Lack of understanding of the variation in the performance of heat pumps at different operating conditions has been identified as causing significant under-sizing in previous field trial reports.

For instance, the standard rating condition for ASHPs used to be air at 7°C and water flow at 35°C. However, in practice they may be required to produce water at approximately 55°C with design ambient temperatures of circa -2°C. At these latter conditions the output of many heat pumps could be as little as 60% of the output at 'standard' (nominal) rating. For example a 13kW ASHP may provide 13kW of heat at 7°C and 35°C flow temperature but it is unlikely to do this at an air temperature of -2°C and water flow at 55°C. The actual output could be as little as 7-9kW and hence, if relied upon for the design of the system, it will be vastly under-sized incurring the cost of expensive supplementary heating and/or lead to issues of poor comfort.

Please note:

Most ASHP, and increasingly, GSHPs have variable-speed inverter compressors. These generally adapt automatically to load demand, often improving efficiency at part load conditions. However, this ability should not be used as a reason for significant oversizing as cycling will occur at lower demand levels due to the limited inverter 'turn-down' available (typically 25%).

Key point:

Many installers use just one preferred manufacturer for supply of heat pumps. Whilst this has advantages with familiarity, associated design, installation and commissioning requirements, it could mean that the heat pump becomes significantly under or oversized if the nearest available size is utilised. In such a situation it may be advisable to seek an alternative manufacturer's product which is more closely matched to the design load, or consult the manufacturer and seek guidance (e.g. increased water volume/install a buffer). The Contractor responsible must weigh up the pros and cons of their actions.

4.0 Selecting and Sizing Heat Emitters

4.1. General

It is imperative to select heat emitters which are suited to the building's needs.

4.2. Heat Emitter Types

4.2.1. Radiators (Natural Convectors)

These are the most popular type of heat emitter due to convenience, industry and user familiarity, and low cost. There are different types of radiator such as single panel, single panel with convector, double panel with single convector etc., each with their own performance. As these emitters will most likely be operating at water temperatures lower than the 'standard' design condition for a combustion based system, they will need to be sized accordingly.

'Oversize factor' is a term that has developed to explain that general heat emitters, being used at lower than 'normal' temperature, need to be larger than 'normal'. It enables Contractors to select a heat emitter using the usual published data rather than having to apply a correction factor on each selection.

Warning: Radiator outputs vary upon the specific relationship between the following set of values:

- a. Design water temperature (flow and return)
- b. Water flow rate
- c. Design room temperature
- d. Radiator type (single, double, convector)
- e. Radiator size

When operating at typical water temperatures provided by heat pumps running most efficiently the actual output of a radiator will be less than its standard 'nominal' rating (based typically on a mean water temperature of 70°C (BS EN 442) and a room to mean water temperature difference of 50°C) and this must be taken into account, especially when checking the heat output of radiators on existing systems for suitability.

Warning: Although 'radiators' are probably the most widely used heat emitter they emit heat principally through convection, warming air in the space which forms natural air currents. They directly radiate relatively low levels of heat into the space. The maximum radiated heat for a single panel operating at an average surface temperature of 65°C is 40%, however with the addition of heat transfer fins (e.g. double convector) this can decrease to as little as 15% and therefore 85% will be emitted via convection.

Please note:

Manufacturers rated output tables before the year 2000 were based on a mean water to room air temperature difference (MWT – AT) of 60°C . For instance, a MWT of 80°C and RAT 20°C.

Later tables are based on a 50°C temperature difference (MWT 70-RAT 20 = 50°C) in accordance with later versions of BS EN 442.

4.2.2. Fan (Forced Draught) Convector/Coil

A fan convector comprises of a series of heat transfer fins with a fan placed over one end to increase the flow of air hence convective effect heat transfer.

These heat emitters are extremely useful in providing relatively high heat outputs for their size (volume), and they are very useful where wall space may be limited.

These devices will need a small electrical power connection in order to operate the fan etc.

Warning: Fan convector outputs vary upon the specific relationship between the following set of values:

- a. Design water temperature
- b. Water flow rate
- c. Design room temperature
- d. Manufacturer
- e. Size
- f. Air flow rate

Warning: As the units have a fan, they are likely to produce more noise than a conventional radiator and each unit requires a power source to run the fan.

Please note:

Fan technology has advanced considerably to reduce noise and minimize power consumption such that they are still a very viable option.

4.2.3. Underfloor Heating (UFH)

Underfloor heating is a series of pipework loops that are embedded into the floor.

As floors generally represent a much larger surface area to emit heat than other systems, they can often deliver sufficient heat into the room while operating at relatively low temperatures which makes them a natural complement to heat pump systems if that heating flow temperature can be replicated throughout the whole building.

It is important to ensure that all rooms have their own independent temperature control capability.

Other benefits of UFH systems can be identified as:

- more even heat distribution as UFH relies less on heat transfer by convection
- improved comfort as floors are not cold and UFH heats people and objects from the floor up
- UFH systems are also beneficial when heating spaces with high ceilings
- It is widely accepted that UFH can reduce energy costs in high heat loss rooms as spaces with UFH tend to be heated to lower air temperatures for the same perception of warmth compared to other heat emitters, and that this reduces heat loss and hence may reduce energy requirements. It also reduces the effect of stratification of air and hence the need for higher temperatures at heights above the occupied space.

UFH should be designed to operate at the lowest possible temperature to achieve the desired demand output. Mixing manifold circuits are often employed however the efficiency of the heat pump will be determined by the flow temperature of the heat pump prior to any mixing hence the rest of the heating system needs to be designed for low temperature operation.

Warning: Underfloor heat outputs vary depending upon the specific relationship between the following set of values:

- a. Design water temperature
- b. Water flow rate
- c. UFH pipe spacing
- d. UFH pipe type
- e. UFH pipe size
- f. Design room temperature
- g. Floor covering
- h. Floor construction
- i. Net/Effective heated floor area
- j. Limits set by BS EN 1264

Typical flow temperatures will need to be higher for floors with coverings that insulate the floor e.g. carpets, wood/manufactured wood coverings etc. Elevating the water temperature to overcome any such 'insulation' will reduce efficiency and tend to replicate the efficiency of a 'traditional' radiator system.

An underfloor heating specialist should be consulted in the design of an underfloor heating system.

Tip: Floor coverings and their implications are an important factor to consider.

The underfloor heating design Standard BS EN 1264 recommends a floor system is designed with a default TOG* value of 1.0.

Some useful points are listed below:

- a. Typical TOG rating for TILES = 0.0 tog.
- b. Typical TOG rating for HARDWOOD = 1.0 tog.
- c. Typical EFFECTIVE TOG rating for Carpet and Underlay = 1.5 tog (BEAMA Underfloor studies show EFFECTIVE TOG is circa 1.0 TOG LOWER than manufacturers stated TOG).
- d. As per BS EN-1264, the maximum TOG rating of a floor covering shouldn't exceed 1.5 tog.
- e. Hardwood flooring should preferably be a maximum of 22mm thick.
- f. Consideration should be given to movement joints where screed, hardwood or tiled floor areas exceed 40m².
- g. The floor surface may exceed 27°C. This information should be passed to the flooring Contractor.

An underfloor heating specialist should be consulted in the design of an underfloor heating system.

*TOG value is a measure of insulation (resistance [m^2C/W]) 1 TOG = 0.10 m^2C/W

Tip: If you can feel the surface temperature as 'warm' on the wrist of your hand (this will usually be more than 28°C) there is a possibility that the floor temperature is too high and/or the room is poorly insulated. Ideally floor surface temperatures should not be obviously warm or cold.

5.0 Systems Design and Pipework Sizing

5.1. General

It is essential that the system is designed to ensure that adequate heat is delivered around the building. In particular, it is vital that the heat pump has the correct flow of water and it is better that there is a bit too much rather than too little. Ideally, some form of flow rate measurement device should be installed to verify this. Too little flow may cause heat pump alarms and operation to cease and excessive flow could cause issues with excessive noise, excessive circulation pump energy consumption, system cleanliness and have an adverse effect on heat pump operation.

Key point:

$$Q = \underline{m} \times SHC \times \Delta t$$

where

Q = Power (kWatts(kW));

\underline{m} = mass flow (kg/s);

SHC = Specific Heat Capacity of water/glycol - typically 4.18 (kW/kg °C) for water and circa 3.9 for water glycol mixes;

and

Δt = the temperature difference (drop) between flow and return

From this equation it can be clearly seen that if the ' Δt ' is reduced the mass flow ' \underline{m} ' must be proportionately increased to maintain the same heat output power otherwise ' Q ' will decrease.

This equation can be used for all types of heat transfer (kW) and energy storage (kWh or GJ) depending whether mass flow rate (kg/s) or water volume mass (kg) is considered.

Energy: stored or released

$$(kWh) = m \times SHC \times \Delta t / 3600 (s/hr)$$

where m = mass of fluid.

Example:

A Contractor wants to compare the pipe sizes required for a heat pump with a flow and return difference of 10°C and a condensing boiler with a flow and return difference of 20°C.

The total duty (power) of heat emitters, Q, is 16.75 kW (remember a kW is actually a kilo Joule/second (kJ/s)).

Flow rate for a condensing boiler with a 20°C Δt (F&R) is:

$$\frac{Q}{SHC \times \Delta t} = \frac{16.75}{4.18 \times 20^{\circ}\text{C}} \text{ units } \frac{[\text{kJ/s}]}{[\text{kJ}/^{\circ}\text{C kg}] \times [^{\circ}\text{C}]} = 0.20 \text{ kg/s (which approximates to 0.20 litres/second)}$$

Select a 22mm diameter (ext) copper pipe with resulting fluid velocity of 0.61 m/s and pressure resistance of 228 Pa/m

Flow rate for a heat pump with a 10°C Δt (F&R) is:

$$\frac{Q}{SHC \times \Delta t} = \frac{16.75}{4.18 \times 10^{\circ}\text{C}} \text{ units } \frac{[\text{kJ/s}]}{[\text{kJ}/^{\circ}\text{C kg}] \times [^{\circ}\text{C}]} = 0.40 \text{ kg/s (which approximates to 0.40 litres/second)}$$

Select a 28mm diameter (ext) copper pipe with resulting fluid velocity of 0.73 m/s and pressure resistance of 226 Pa/m

Some HP's have a Δt circa 5°C (F&R) in which case this will double the flow rate required for the same power (kW) delivery and in the case above would require a flow rate of 0.8 kg/s, suggesting a pipe size of 35mm diameter with a pressure loss of 268 Pa/m @ average velocity of 0.95 m/s.

Warning: The flow rates for heat pumps tend to be greater than for the equivalent size of other heating devices. This is due to the relatively low temperature differences between flow and return (e.g. heat pump 5°C, condensing boiler 10°C: this will double the mass flow to achieve the same output).

Please note:

The UK went metric in the 1970's therefore kW should be used rather than Btus/hr etc. This will assist in calculating the output of the heat pump, flow rates etc. However, some heating product distributors still quote emitter outputs primarily in

$$\begin{aligned} \text{Btu/hr: } 10,000 \text{ Btu/hr} &= 2.93 \text{ kW,} \\ 1 \text{ kW} &= 3,412 \text{ Btu/hr.} \end{aligned}$$

Doing this adds unnecessary complication and can lead to errors.

5.2. Heat Pump System Type Options

• Space Heating Only

The heat pump provides heat only to heat the space. Domestic hot water for sanitary purposes (if required) is provided by a separate system which may or may not be another heat pump.

• Domestic Hot Water Only

This heat pump is dedicated to heat up domestic hot water. Any space heating requirement is supplied by alternative means. This can be a popular solution on large projects such as multi residential apartments when services are centralised e.g. heat network systems.

• Combined Space Heating and Domestic Hot Water

This is currently the most installed type system with a further two options:

- Heat pump with a separate and physically remote hot water tank (see figures 2 and 3).
- Heat pump with integral or directly connected hot water tank and combined controls: ‘Combination Heat Pump’.

Figure 2.

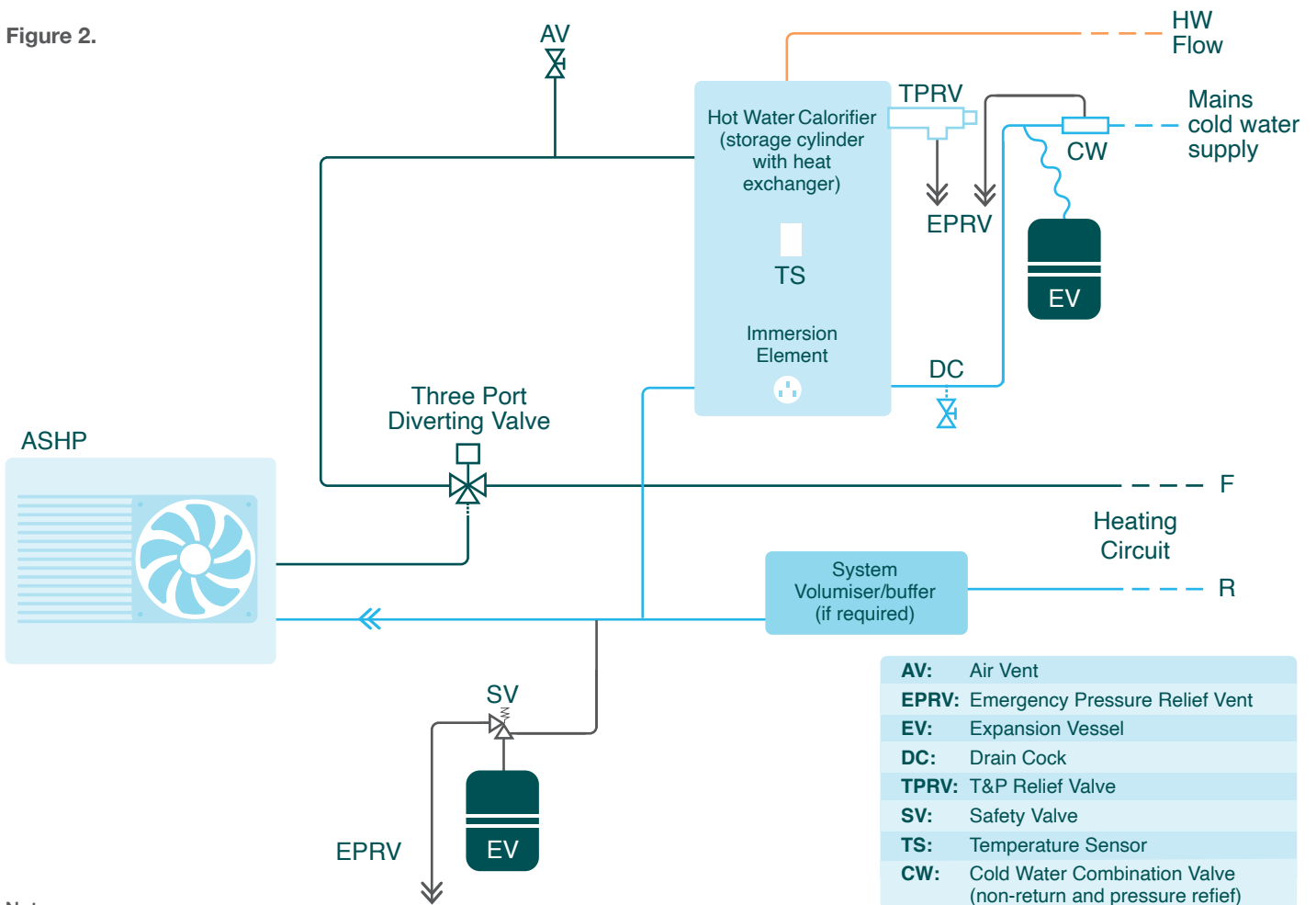

Notes:

Please refer to G3 and other regulations for greater detail on compliance. All pressure and temperature relief devices to discharge via tundishes.

Figure 3.

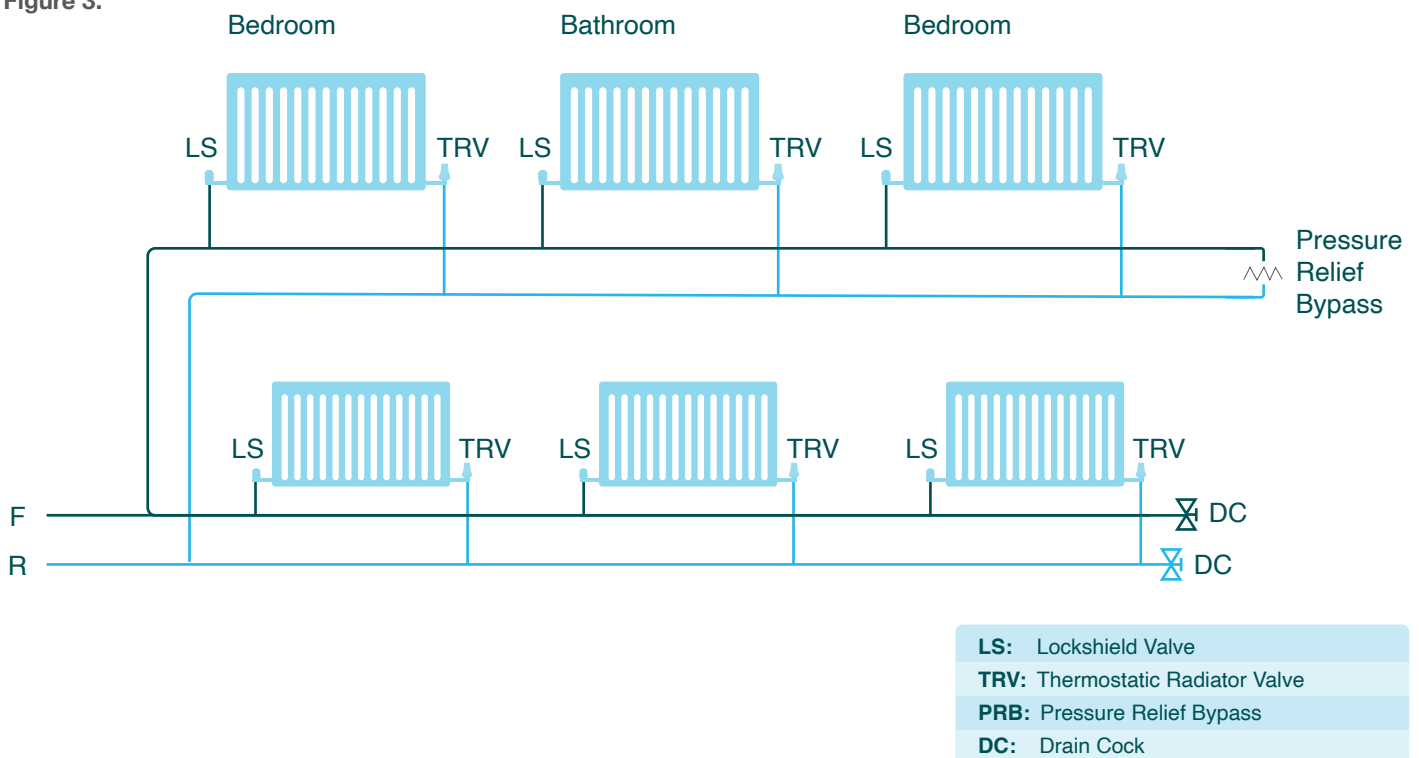

5.3. Pipework Materials

The choice of piping materials is common to all ‘wet’ heating systems and such materials should be suitable for the application in terms of pressures and temperatures likely to be experienced. In that regard, heat pumps are moderate in demand. Full pipe sizing, pressure loss calculations and pump selection are beyond this guide but there are tools available to assist such as those available from CIBSE and CIPHE.

Warning: Whilst the outside diameter of standard pipework may be the same for copper and plastics, it is the inside bore diameter which impacts on the flow of the fluid and hence velocity and frictional resistance. The inside bore diameter varies considerably between plastic and copper and even amongst different plastic materials and pipe manufacturers. Pressure drop and flow rate charts for the particular material should be used. In general, velocities of fluid in smaller bore pipework should be < 1 m/s and ideally the pressure drop < 300 Pa/m (Pascal/metre).

Please note:

Mini-bore pipework (6, 8 & 10mm diameter) is generally not suitable for heat pump installations.

6.0 Controls Options

6.1. Space Heating Controls

6.1.1. Time Controls

There are different opinions amongst specialists about whether heat pump systems should be run intermittently (time clock controlled) or continuously. Local Building Regulations will likely require some form of time clock / programmer control but may not stipulate the settings. The designer of the system must take overall responsibility for the control regime after discussion with the system owner but should not default to 24/7 operation as a 'safety' factor.

6.1.1.1. Intermittent

Intermittent heating is where the plant is switched off at the end of a period of predicted building occupancy and turned on again prior to the next period of predicated occupancy in order to return the building to design conditions. With this type of heating control system some margin in the output of the heat source and heat emitter should be allowed for in order to ensure an ability to reach an acceptable room temperature within a reasonable time, particularly at or near design temperatures (external).

Warning: A balance must be struck between adequate capacity to heat up and recover the room design temperature after an 'off' period or a set back condition, and not excessively oversizing the system so that it cycles excessively during low heat load conditions. The provision of auxiliary heat sources may reduce the margin required, since it would be unusual to have to re-start a system from completely cold at a design outside temperature, and hence it is debateable just how much margin to provide.

6.1.1.2. Continuous

As its name suggests these systems have no actual time clock control. The system is 'on' all the time, usually depending on a manually adjustable thermostat or temperature sensor.

Please note:

Continuous does not mean the unit will run continuously but that it is 'enabled' to run continuously. As noted previously this practice is questionable as to whether it complies with common Building Regulations.

6.1.1.3. Combined Intermittent and Continuous (Set Back)

This refers to programmers which enable different temperature set points to be scheduled at different times. For example, overnight a lower temperature is acceptable enabling the system to turn off for a while. However, the same may be true if the dwelling is largely unoccupied during the working day.

In a sense, the system is continuous in that it is enabled all the time, but the temperature settings vary during the day and hence are effectively intermittent and determine if the system is actually running or not.

This could also be used where different forms of heat emitter are used, such as radiators and UFH. The UFH may have its set back temperature enabled and returned to occupancy levels much earlier than the radiator heat emitter circuit depending on the reaction time.

6.1.2. Temperature Controls

6.1.2.1. Room Sensors/Set Point Controllers

It is essential that any user interface controls are simple to use and well explained to the end user. Ideally, some form of temperature control should be available in all rooms either by thermostatic radiator valves (TRVs) in the case of radiators or zone control valves for UFH.

Warning: It is essential that the heat pump has adequate water flow rate and system volume at all times.

Water flow rate can be achieved using auto pressure relief bypass valves, open circuit zones (i.e. no auto closing devices such as TRV's) or low loss header/buffer vessel.

Adequate system volume for the purpose of reducing cycling during low load and/or to assist in the defrost of ASHP systems should be checked and if required, a correctly sized buffer or system volumiser should be installed. Check manufacturers recommendations.

6.1.2.2. Radiators

Typically, individual radiators will have trimming control of the room temperature via TRVs. These are a relatively low cost, passive methods of providing user comfort control, whilst also conserving energy by reducing the risk of overheating the space.

Tip: TRVs should be exercised during long periods of no load to reduce the risk of them sticking in position.

6.1.2.3. Underfloor Heating (UFH)

Typically, individual rooms will be controlled via a thermostat in each room with balancing flow regulation valves for each loop of pipe.

Warning: The use of blending valves is a common component of UFH manifolds required with high temperature heat sources (>60°C). However, care must be taken with heat pumps as it may be better to produce the flow temperature as low as possible in the initial design rather than blend down. Using blending valves and pump sets at UFH manifolds may assist with correct flow for heat transfer and system cleanliness if the primary side heating pump has insufficient duty (i.e. pump pressure) for the circuits it serves.

Scenario:

Mr Smith wants to install a heat pump system in his home and would like underfloor heating downstairs and radiators on the first floor. The MCS Contractor (Designer) obtains a specialist design for the UFH to operate at 45°C and hence selects radiators for the first floor based on the same maximum design flow temperature (good practice). The radiators are consequently a little 'larger' than would be suggested for a system running at a higher temperature (e.g. a system using a combustible fuel). Mr Smith initially rejects the design because he wants to keep the radiators upstairs as small as possible and his preferred sizes would require a maximum flow temperature of 55°C. The MCS Contractor (Designer) explains that the whole system will have to run at 55°C and the temperature blended down to 45°C for the UFH. Therefore, the efficiency of the system will be dictated by the higher temperature requirement and this will reduce the efficiency of the whole system by about 15%. Mr Smith is keen to optimise efficiency and accepts the original design and accommodates the 'larger' heat emitters into the first floor plan layout. (NB: The MCS Installer could consider and offer UFH for first floor as well, if appropriate).

6.1.2.4. Fan Coil Units

Typically, individual units will be controlled via a controller located in the unit or a separate room thermostat.

Fan coil emitters have a heater matrix with a fan to aid heat transfer from the matrix to the air and to aid circulation within the heated space.

Warning: Since fan coils have active components, they will emit more noise than a passive system (e.g. 'radiator'). However, noise levels are normally very low as units are designed for use in all rooms including bedrooms. The installer should discuss this with the consumer to ensure they are aware of this and possibly consider some kind of practical demonstration or visit an installed unit.

Please note:

Consumers are unlikely to appreciate what the noise level figures - dB(A) - mean in practice.

6.1.3. Weather Compensation

Weather compensation (more accurately described as Ambient Air Temperature Load Correction) endeavours to improve the efficiency of the heat pump during seasonal operation by recognising that the output of most heat emitters does not need to be set at maximum during low load conditions. This means that the flow temperature can be reduced, which in turn will ordinarily increase the efficiency of the unit.

Example:

(See figure 4 below) a heat pump system may be designed to give sufficient heat at say -3°C outside air temperature, at which point the space heating flow temperature will be whatever the maximum temperature design temperature has been set at, say 55°C . As the temperature outside increases the maximum flow temperature will be proportionately decreased so that it would be 30°C at 16°C outside. Thus, when the ambient temperature is 7°C the flow temperature would be circa 43°C to compensate for the lower heating demand.

Tip: Minimum Flow Temperature: The temperature of the space heating water flow needs to be sufficient to effect heat exchange from the emitter to the room and to provide a significant load on the heat pump (see 7.2.1 Water content and buffer vessels on page 30 and 11.1 Minimum system water content on page 35) regarding adequate system volume and flow rate.

MCS requires weather compensation to be available on all space heating systems but does not stipulate how this must be set up.

Warning: Some heat emitters e.g. fan convectors and underfloor heating, do not react in a linear manner to flow temperature reduction and hence output, therefore a specialist provider should be consulted as to how the compensation should be set up.

Figure 4.

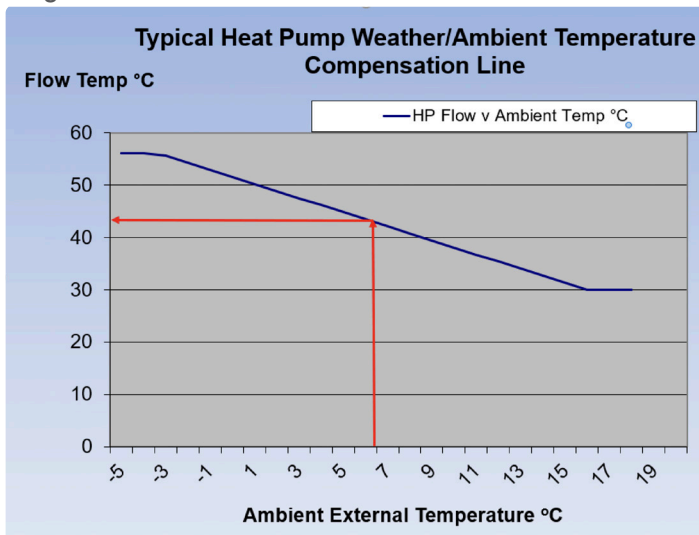

Notes:

The red line shows the standard test outdoor condition (BS EN 14511) which is at 42°C flow temperature hence this nominal output is likely to be higher than that experienced in practice.

6.1.4. Optimised Control

Optimised controls compare how close the system gets to the set point conditions in the controlled space at the time the temperature is required. These controllers 'learn' how the building reacts to heat-up periods and adjusts the start time depending on room temperature and outside temperature. These controls are becoming much more widely available and many manufacturers now build these functions into their controllers.

6.1.4.1. Smart Metering

The UK Government is encouraging the roll out of smart meters but there is no obligation to have one. Smart meters at present do not indicate the energy consumption of individual devices.

6.1.4.2. Smart Tariffs

In the future there is a potential for 'smart' electrical tariffs linked to truly smart controls and meters whereby the operation of the heat pump is influenced by the 'spot' price for the fuel or possibly another metric such as grid carbon factor/demand on the grid at the time. 'Spot' prices for electricity are usually updated every 30 minutes. It is not known currently if such 'smart' tariffs would go to this granularity. However, such 'smart' controls would facilitate systems to store heat, such as in the domestic hot water cylinder, at times of low demand which often coincides with lower tariff costs and potentially lower grid emission factors.

6.2 Hot Water Controls

It is important that the production of hot water is addressed to ensure hot water is available as and when required (i.e. time control). In order to minimise running costs the heat pump controls should be set up to deliver the flow temperature appropriate to the function, i.e. hot water generation will likely require a higher flow temperature from the heat pump than when providing heat for space heating, especially if the latter has weather compensation flow temperature adjustment. Complete separation of flow temperatures for space heating and hot water (when provided by the same heat pump) will optimise the efficiency of the heat pump particularly in space heating mode.

Ideally heat pump flow temperatures for hot water generation should be 55°C or greater. This temperature will assist in reducing the multiplication of potentially harmful bacteria such as legionella pneumophila which can result in a pneumonia type infection known as 'Legionnaires Disease'. Legionella bacteria stop multiplying at temperatures above 50°C and are 'killed' by temperatures > 60°C. Occasionally stored water should be heated to 60°C in order to pasteurise the cylinder. Typically, this is carried out weekly but can be required more or less frequently, and further advice should be sought.

7.0 Optimising Unit & System Efficiency

7.1. Measuring Efficiency

Efficiency of most technologies is normally quoted in percentage terms, however because the source power or energy derived from the air, water or ground is not taken into account, only the energy to extract it, the efficiency of a heat pump system will always be greater than 100%, which can seem counter intuitive. Therefore, a ‘Coefficient of Performance’ (CoP) is used. In other words, the result is not multiplied by 100, which renders it as a coefficient rather than an efficiency (see Table 2).

Table 2. Differentiation of Instantaneous and Seasonal Performance (Power & Energy)

	Description	Units	Designation
Instantaneous	Power Out/Power In	(kW _h /kW _e)	CoP
Seasonal	Energy Out/Energy In	(kWh _h /kWh _e)	SCoP or SPF

Notes:

kW_h = Heat Power output (kW) to the heating system (i.e. load or ‘sink’ side)

kW_e = Electrical Power Input into the HP in kW

kWh_h = Heat Energy output (kWh) to the heating system (i.e. load or ‘sink’ side)

kWh_e = Electrical Energy Input into the HP in kWh

Heat pump efficiency can be determined using a number of coefficient metrics.

- i) Predicted pre-installation and during monitoring **a.** Heat pump unit itself **b.** The ‘system’
- ii) Measured post-installation **a.** Heat pump itself **b.** The ‘system’

In addition, the coefficient of performance (efficiency coefficient) can include different parts of the heat pump and associated system. For instance, it may or may not include any additional supplementary heating that may be required or include or exclude all or some of the various circulation pumps employed. This is in addition to the heat pump itself. So, the ‘system boundary’ defines how much of the system is actually included in the analysis and hence the coefficient value.

These inclusions and exclusions are described as ‘boundaries’ and have been well defined by ‘SEPEMO’ - the ‘Seasonal Performance factor and Monitoring’ - for heat pump systems projects as recorded by the European Heat Pump Association (EHPA).

The diagram below illustrates the SEPEMO ‘boundaries’ now commonly agreed upon. Hence when quoting the efficiency of a heat pump not only is it necessary to state the operating conditions (source and deliver temperatures) but it is also necessary to state the system ‘boundary’.

Figure 5

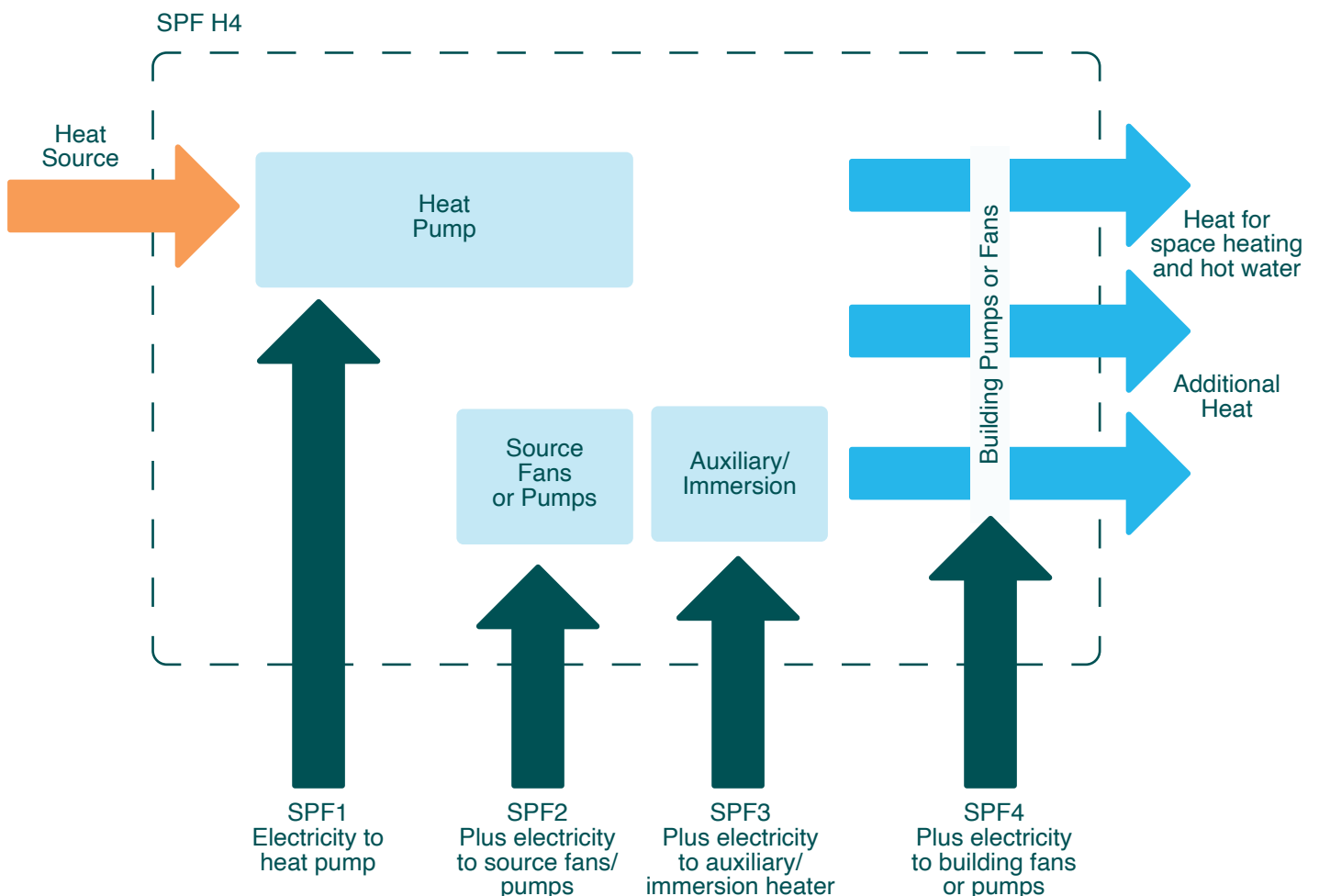

Please note:

Even those experienced in heat pump technology often confuse SCoP and SPF. This is not helped by the European Renewable Energy Directive which states a minimum 'SPF' for a heat pump within a system to be classed as renewable when in fact it actually refers to a 'SCoP', and at SEPEMO⁸ boundary 2. ErP labelling and Eco-Design use SCoP and a predetermined SEPEMO⁸ boundary 3 condition.

In general SCoP focuses on the device in a theoretical 'standard' situation which is NOT project specific, whereas SPF either forecasts or measures the efficiency in a specific installation. SPF may also include hot water as the seasonal efficiency metrics SCoP and SPF normally refer to space heating efficiencies. Hot water efficiencies are still quoted in instantaneous mode (CoP) however later editions of BS EN 16147 may change this.

7.2. Heat Pump Operating Efficiency

The efficiency of the heat pump and associated system can be influenced by a number of factors.

7.2.1. Water Content and Buffer Vessels

All systems should have adequate thermal capacity to store quantities of heat to avoid the heat pump from cycling on and off too frequently.

System water content should comply with the manufacturers requirements and advice. Water volume can be very important for air source heat pumps during any defrost cycle for the outdoor evaporator.

7.2.2. Circulation Pumps

Caution should be exercised in the number of circulation pumps installed and how they are controlled. Circulation pumps should have a specific purpose and only be used where they are specifically needed. Evidence suggests that multiple circulation pumps are often used on larger systems with multiple circuits all with differing flow rates and pressure requirements. Also, systems employing buffer vessels as 'low loss headers' (i.e. four pipe buffers) often consume relatively high levels of energy to drive the pumps which can impact on the overall system efficiency. Furthermore, the uncontrolled use of circulation pumps can have a similar effect. For instance, the ground array pump for a GSHP system should not be run 24/7 but should be controlled in some way to match demand for heat, most likely taking a signal from the machine itself.

In GSHP systems ground arrays need to be designed to avoid high pressure drops. The use of manifolds can assist with this by forming multiple array loops in parallel rather than in series. In addition, the Thermal Transfer Fluid (TTF) can impact negatively on efficiency if inappropriately selected or applied. The GSHPA offer advice in this regard.

⁸ SEPEMO: <http://sepemo.ehpa.org/>

7.2.3. Controls

There are a number of excellent control packages available both via the heat pump manufacturer and separately.

The Installer should explain to the user that changing temperature set points dramatically does not make the system react significantly quicker but will most likely end in an overshoot situation, i.e. excessively high room temperatures. For more information on controls see 6.0 Controls Options on page 23.

7.2.4. Temperature Set Point

It is advisable that when designing the controls for any heat pump space heating system consideration should be given to the provision of ‘weather compensation’- (see Section 6.1.3 Weather Compensation on page 25). It would appear for suitable heat emitter systems such as radiators, but not fan convectors/coil or UFH, that it is not desirable to have an excessively low minimum design temperature just as it is not desirable to have excessively high a maximum design flow temperature. Consideration should be given to set the minimum heat pump flow temperature to around 30°C and ideally size the radiators for a maximum flow temperature around 45°C. Suitable maximum flow temperatures should be selected for other heat emitters depending on the selection design temperatures.

Key point:

The efficiency of a heat pump is fundamentally affected by the temperature of the heat source (e.g. air, ground or water) and the flow temperature delivered by the heat pump. The higher the source temperature and the lower the flow temperature the greater the efficiency will be.

Figure 6.

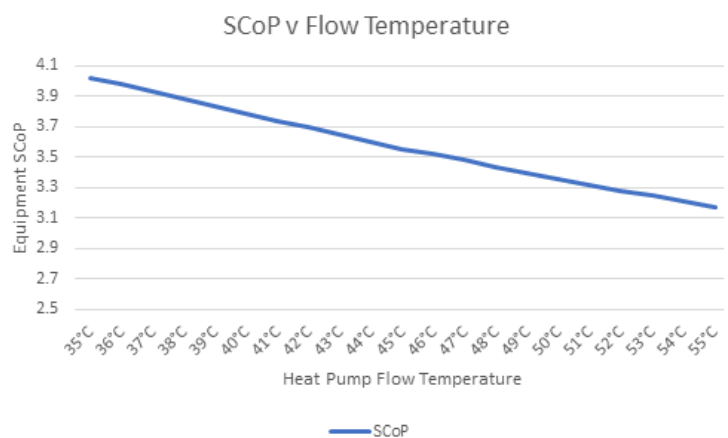

8.0 Installation and Commissioning Advice

Manufacturers' instructions and those of any designer employed should be rigorously followed. If in doubt a query should be raised with the appropriate party.

A number of manufacturers and installation best practice schemes (e.g. Benchmark) provide an installations checklist and it is recommended these are used where possible.

Typical areas which need attention are:

- To ensure adequate space for access for maintenance, servicing, adjusting set points and/or flow valves, reading meters etc.
- To ensure pipe runs are the correct size, routed to minimise unnecessary bends or changes of direction, and are well supported and insulated where required.
- To ensure that hydraulic systems are properly pressure tested, have water treatment added as directed, and are adequately vented and flow rates checked.
- To ensure that heat emitters are hydraulically balanced using appropriate valves (lockshield on radiators, flow control valves on under floor heating circuits) to provide the desired flow rate to provide a similar temperature difference across the emitter.
- To provide a clear operating and maintenance manual including any recommended spares, plus contact details, for all relevant parties and major equipment suppliers.
- Care must be taken in the siting of the outdoor unit of an air source heat pump to ensure adequate air flow and that the unit does not cause a noise problem to occupants or neighbours. Modern HP units emit very low levels of sound. MCS 020 gives guidance on the noise levels acceptable in the Permitted Development Planning rules. Devolved rules should also be consulted. .

9.0 Operating Advice

Installers should always explain to the end user how the system should be used.

This includes information on:

- Changing set points and time settings (as appropriate).
- Operating any programmer provided, including what should and should not be changed by the user.
- Running the system in the most economical way.
- What to do in the event of abnormally high hot water consumption and how to re-heat the store as quickly as possible.
- How to leave the system during normal vacation periods or longer periods of vacation.
- Any regimes to prevent the propagation and growth of bacteria within the system (e.g. legionella).
- Service and maintenance schedules, including a log book to record all relevant system checks and changes.

The Installer should also inform the consumer that they may wish to consider what the optimum fuel tariff would be for them, giving suitable advice wherever possible.

10.0 Maintenance Advice

10.1. General

There is a degree of uncertainty and inconsistency in advice on maintenance of heat pump systems. This is because the heat pump unit itself is most often a contained unit sealed during manufacture, similar to a domestic refrigerator which requires minimal maintenance. However, the system to which they are attached often needs periodic servicing. Therefore, it is important to differentiate between maintenance of the heat pump itself and the overall heating and/or hot water system. The recommendations of the manufacturer should always be followed. It is unlikely that more than one service inspection per year will be required.

10.2. Air Source

In general, all air source, outdoor units should be checked to ensure the airflow through them is not impeded in anyway by the build-up of matter blown in by the wind (e.g. leaves and general debris) or from the growth of vegetation.

This does not necessarily need to be performed by a specialist.

10.2.1. Monobloc Systems

It is important to ensure that the fluid heat transfer system has adequate anti-freeze in the circuit. How regularly this is checked (via a chemical check) will depend on the evidence or record of any leaks.

10.2.2. 'Split' (Two-piece) Systems

It is recommended that periodic checks are made to ensure that the refrigeration system is in good order. It may be a requirement on larger systems containing more than usual refrigerant to have an annual "F-gas" inspection. Inspection frequency is based on the Global Warming Potential (GWP) of the refrigerant multiplied by the quantity of refrigerant required and/or installed at commissioning.

10.3. GSHP & WSHP Systems

GSHP and WSHP systems benefit from periodic inspection particularly on the 'source' side. The load (heated space) side systems should be maintained in line with normal industry practice with particular attention given to fouling of filters, dosing and maintenance of flow rate which is quite important to a heat pump of any genre.

GSHP Systems:

Closed loop (ground or water): It is important to ensure that the closed loop circuit is clean, free of any biofouling build up, free of leaks/fully filled and the Thermal Transfer Fluid (TTF) contains adequate anti-freeze to prevent freezing.

Leaks can be detected by:

- Visual check of the array
- Monitoring of any automatic refill systems, for instance via a dedicated water meter
- Checking the concentration of anti-freeze chemical (chemical must be identified)

11. Specific Requirements of Heat Pump Units and Systems

11.1. Minimum System Water Content

The ability of many modern heat pumps being able to reduce the maximum output via some form of capacity control (e.g. inverters speed controlling the compressors) has, in many cases, reduced the need for volume control of the system.

Some manufacturers do not require any form of system water content control, whilst others support this either through volumisers or buffer tanks. However, good practice dictates that the system should contain sufficient water volume to assist in preventing cycling of the heat pump unit due to low loads which usually occurs during milder conditions.

Warning: It is vital that the system does not cycle on and off repeatedly as this will lead to excessive wear on the components, poor comfort control and reduced system efficiency.

11.1.1. System Volumisers

These are vessels which increase the water volume of a system to prevent cycling and/or provide a reservoir of heat for defrost operation (ASHP). Often referred to as buffer vessels, but will usually have only two connections, inlet and outlet, being in series in the circuit and constantly part of the circuit.

11.1.2. Buffer Vessels

These are vessels which are often installed to increase the water content of a system although this function can be achieved using system volumisers. More often than not their role is to create primary and secondary systems allowing different volume flow rates and/or temperatures in each circuit (therefore minimum of four connections, two in and two out).

Other types of buffer have two pipes, but these are only employed when other circuit volumes are not in circuit (e.g. underfloor heating systems) except with a constant flow.

Warning: Buffer vessels can perform important functions if incorporated correctly, however they can also increase heat loss from the system and add additional parasitic load from additional circulation pumps, which may also have to work in continuous operation. Therefore, their inclusion should be carefully considered and the advice of the manufacturer or a specialist sought.

Example:

A 12kW nominal inverter controlled heat pump unit (at 7°C ambient and 35°C water flow) can provide an output of 4kW at maximum turn down (minimum output) at an ambient of 12°C and weather compensated flow temperature of 30°C.

What is the minimum water content to ensure cycling does not exceed six starts per hour?

Assume acceptable temperature drop of fluid is 5°C and the fluid has a SHC of 4 [kJ/°C kg] because it has antifreeze in it (normally 4.18 [kJ/°C kg])

Total heat energy required:

$$4 \text{ [kW} = \text{kJ/s} \times 60/6] \text{ [minutes/number]} \\ \times 60 \text{ [secs/min]} = 2,400 \text{ [kJ]}$$

$$\text{Mass of water required [kg]} = 2400 \text{ [kJ]} / \\ (4 \text{ [kJ/}^\circ\text{C kg]} \times 5 \text{ [}^\circ\text{C]}) = 120 \text{ [kg]}$$

Assume 1 kg of water = 1 litre, therefore 120 litres required.

11.2. Air Source Heat Pump Systems

ASHPs need to be situated carefully to ensure adequate air flow across the unit and to contain any unacceptable sound transmission.

11.3. Ground/Water Source Heat Pump Systems

The extraction of heat and recovery of the ground/water source is critical to the operation of the system and hence it is recommended that the services of an experienced ground/water source designer are employed. Rules of thumb cannot be used for the final design of an array/water source. When using either the MCS look-up tables or commercially available ground/water source design software it is vital the user understands the limits of these tools, the parameters to be input, the effect these parameters have on the calculations and are able to correctly interpret the outputs. As a minimum, a thermogeological survey report for the specific site is likely to be required to source the necessary input data.

The ground array should be designed following guidelines provided by the Ground Source Heat Pump Association (GSHPA).

11.4. Exhaust Air Heat Pumps

These systems, which come in a limited range of 'smaller' sizes, are ideally suited to smaller, highly insulated dwellings. Their performance can be considerably increased by the incorporation of additional low running cost/low carbon supplementary heating such as wood burning stoves, since the heat pump can extract heat from the exhaust air system.

11.5. Gas Absorption/Adsorption Heat Pumps

As the heat generated in GAHP systems uses relatively low levels of energy to drive them, all heat generated in the process is 'useful' heat that can be transferred into the system. The efficiency of a GAHP system is measured by Gas Utilisation Efficiency (GUE) which is defined in EN 12309 as the ratio of energy output to energy input. Originally, this used the Net efficiency of natural gas - which slightly exaggerates performance - however the Standard now requires the Gross efficiency figure to be used which includes the latent heat contained within gas. This is the part that condensing boilers benefit from when condensing.

11.6. Gas Engine Heat Pumps

More than 95% of heat pumps sold in the UK use electricity as the driving fuel, however other fuels such as natural gas and LPG can be used for specifically designed machines either using the heat directly - as in GAHP systems - or using it in an internal combustion engine-type arrangement (GEHP). GEHPs are very rare in the UK but more popular in Asia in general and Japan in particular.

11.7. Solar Assisted Heat Pumps (SAHP)/ Thermodynamic Panels

There is limited information available as to the performance of these systems, particularly over the annual cycle, therefore caution should be given prior to their installation. Effectively they are ASHPs with a passive or fan-less evaporator collector.

11.8. Heat Recovery Heat Pumps (HRHP)

These heat pumps are traditionally air-to-air heat pumps recovering heat from exhaust air and transferring it to fresh air intake, this contrasts with EAHP systems which are air-to-water.

11.9. Hybrid Systems

11.9.1. Controls Considerations

Hybrid heat pump system are heat pumps which provide heat in conjunction with other alternative sources of primary energy (e.g. Natural Gas, LPG and Heating Oil) and are jointly controlled by a single dedicated controller (see Clause 4.2.1 g) on page 82).

11.9.2. Controls Considerations

A Hybrid heat pump system will have a dedicated controller controlling ALL heat sources.

Great care must be taken when designing, installing, setting up and commissioning the controls to ensure that the original intent is achieved in practice. Decisions must be made as to the protocol for control such as:

- i) Concurrent Operation also known as co-valent or parallel operation: this is where 100% of the system load cannot be provided just by the heat pump so it is supported by an additional heat source
- ii) Sequential Operation, also known as alternative or bi-valent: with this type of control one heat source is disabled and the other enabled to take 100% of the load

Concurrent Operation: It must be assured that the return temperature to the heat pump must be within the operational limits of the device and to the desired temperature as combustion systems will tend to have a higher flow temperature and therefore a higher return temperature, which may not suit a heat pump.

Sequential Operation: It is important to ascertain what will trigger a change from one heat source to another such as:

- a. Fuel tariff
- b. External temperature (i.e. predicted load)
- c. Instantaneous Carbon content of the grid
- d. A combination of predicted efficiency based on the external ambient temperature and either the fuel cost or carbon content

Whatever protocol is chosen it is paramount that the controller is properly programmed and set up to operate this way and what input the user may or may not have is clearly explained.

11.10. Choosing Fuel Tariffs

It is an implied function that MCS Installers should give some direction regarding heat pump energy tariffs to consumers. Especially where it is proposed to move from a source of heat such as oil, gas, LPG, coal, economy 7 electric storage heaters or even direct electric consumption. For instance, it is often the case that a tariff with a low standing 'fixed' charge per day and higher tariff price might suit a low consumer of electricity (e.g. 3,000 kWh pa). However, if an electrically driven heat pump were installed to displace another fuel (e.g. oil) then the situation may reverse considerably and the annual consumption might rise to, for example, 9,000 kWh and a tariff which has a high standing 'fixed' charge but a relatively low unit charge may now prove more cost effective overall.

It is widely accepted however that most suppliers' standard variable rates do not represent the best deals and other tariffs should be investigated. The UK government is considering limiting the price range of standard variable tariffs.

11.11. Future Heat Pump Tariffs or Smart Control?

Heat pumps are ideally placed to benefit from fully functional smart controls i.e. signals from suppliers that can enable and disable equipment based on information received regarding the grid load. This can be in terms of a time of day, daily/hourly variable tariff, grid carbon intensity or other information.

There is also the future possibility of tariffs that better match the profile of heat pump use; hence installers should keep up to date with such developments and relay this information to all current and future projects.

Guidance
Section

Contractual Issues
Getting the contract right



1.0 Introduction

As the introduction to this guide makes clear, MIS 3005 includes the technical rules that are used as a benchmark for certification. The Standard also describes a number of contractual requirements that must be met by installers. For example, those obligations state that specific information must be given to consumers before any contract can be agreed.

The contractual rules and options described in MIS 3005 need to be understood within the wider context of the legal obligations placed on companies selling goods and services direct to consumers. This can cause confusion. Seemingly small changes in sales practice can have important legal consequences. As a result, installers frequently seek guidance from MCS and the Consumer Codes on contractual issues. This part of the guide offers best practice guidance explaining:

- the contractual rules in MIS 3005 within the context of the wider legal framework of consumer protection that exists; and
- how to get your contracts right – with emphasis on performance claims.

This guidance will help you create sound agreements with customers and help you avoid disputes.

Please note:

MCS members must be registered with a Consumer Code approved by the Chartered Trading Standards Institute (CTSI) of which the Renewable Energy Consumer Code (RECC) is one.

2.0 Consumer Journey Options

Summary – understanding the routes to contract

The MCS consumer journey options.

Under the MIS 3005 Standard, the consumer contract can be agreed either before or after you have completed the room-by-room home survey¹.

Your obligations depend on the processes you deploy.

A variety of consumer journeys from sales enquiry to installation are possible but the precise MCS and legal obligations that will apply to you will depend on the ‘journey’ processes you deploy as an MCS Contractor.

The Energy Performance Certificate (EPC).

The property must have a valid EPC². If the customer does not yet have a valid EPC available, you can offer the consumer information, and even a preliminary cost estimate³, but the provision of the valid EPC is essential for the MCS and RHI process.

Consumer journey flow charts.

The most likely consumer journey scenarios are detailed in the consumer journey flowcharts on pages 38 and 39. These flowcharts indicate routes to installation with other options depending on the choices made by the consumer and the survey results. These diagrams indicate what information must be provided at key stages in the process.

¹ MIS 3005 Standard 4.2.17 and 4.2.18.

² A domestic EPC that is less than 24 months old at point of application and if the EPC recommends loft and/or cavity wall insulation this must be installed before application.

³ You can also offer information based on estimates obtained from the RHI Calculator or you can refer customers to the calculator: <https://renewable-heat-calculator.service.gov.uk/>

2.1 Introduction

Why a written contract?

Written contracts help businesses avoid disputes by preventing confusion. They help protect consumers and installers and are essential for microgeneration because installers must give consumers very specific information about the service and products they are selling. Microgeneration contracts become binding when the consumer signs the written agreement. But, under certain circumstances, the entire agreement can still be cancelled; this depends on how and where the agreement was made (see 3.0 The Right to Cancel on page 42).

Under MIS 3005 the written contract can be agreed either before or after you have carried out the full room-by-room survey⁴. As a result, a variety of consumer journeys from sales enquiry to installation can be deployed; but different rules and laws apply to the consumer 'journey' options available.

This section describes the most likely consumer journey scenarios on pages 38 and 39. These consumer journey flowcharts indicate routes to installation with other options depending on the choices made by the consumer and the results from site surveys.

2.2 The Energy Performance Certificate (EPC)

The MCS compliant consumer journeys on pages 38 and 39 start when the consumer has a valid EPC⁵. Any estimates of cost and/or incentive scheme income that you give the customer before the valid EPC is available will be superseded by the formal quote you offer.

The EPC underpins the compliant process for the following reasons:

1. The EPC is not a perfect measure of energy heat demand and should not be used for sizing the heat pump. However, the standard methodology that underpins the EPC can be used as the basis for a quote and contract. MCS Contractors can now choose to offer a quote and contract before the room-by-room survey is completed, (see also 2.4 Consumer Journey 2 on page 37).
2. The DRHI is calculated using the EPC. This means that you must use the EPC (not your own survey of energy demand) to calculate any estimate of RHI income.
3. MIS 3005 specifies one compulsory method for calculating predicted system performance and how that performance should be given to consumers – the MCS Heat Pump System Performance Estimate. This is based on the EPC and should help consumers obtain quotes on a like-for-like basis.

⁴MIS 3005 Standard 4.2.17 and 4.2.18.

⁵A domestic EPC that is less than 24 months old at point of application and if the EPC recommends loft and/or cavity wall insulation this must be installed before application.

2.3 Consumer Journey 1

Most installers will be familiar with Consumer Journey 1 (see page 38). A full room-by-room property survey is carried out before the consumer is offered a compliant quote and the compulsory MCS Heat Pump System Performance Estimate. The consumer can obtain quotes from other companies on the same basis. If the consumer chooses to proceed, the contract agreement is based on that formal performance estimate and a full description of the emitters chosen.

2.4 Consumer Journey 2

The alternative route to installation, as outlined in Consumer Journey 2 on page 39, enables installers to agree a contract before the full design site survey is agreed on the basis of a formal quote and the compulsory MCS Heat Pump System Performance Estimate. Both are offered 'subject to full design site survey' (see 2.6 The Variation of Contract on page 41). If the price changes or there is a substantive change to the design, then a variation to contract must be agreed and signed by the consumer.

Start Consumer Journey 01 here



Is there a valid EPC for the property? (see note 1, page 40).

YES

NO

Start process to obtain EPC

You may be able to offer outline quote but not an MCS Performance Estimate

See Consumer Journey 2 on page 39

BEFORE

AFTER

Will you ask the consumer to sign contract before or after the full design site survey?

DESIGN ONLY

DESIGN & INSTALL

Is the contract for design only or design and install?

Is the site suitable?

YES

NO

END

Carry out full site survey

Issue compliant quote and performance estimate

This must include the compulsory performance estimate (Note 2)

Consumer must be given notice of right to cancel (Note 3)

Carry out full site survey

Consumer pays for full survey and design

Consumer can use design to obtain like-for-like quotes

Give consumer performance estimate and Quote for Install if required (see Note 3 on page 40)

Consumer opportunity to compare quotes and performance claims

Consumer agrees to proceed?

YES

NO

END

Issue contract to sign and include notice of right to cancel

Installation

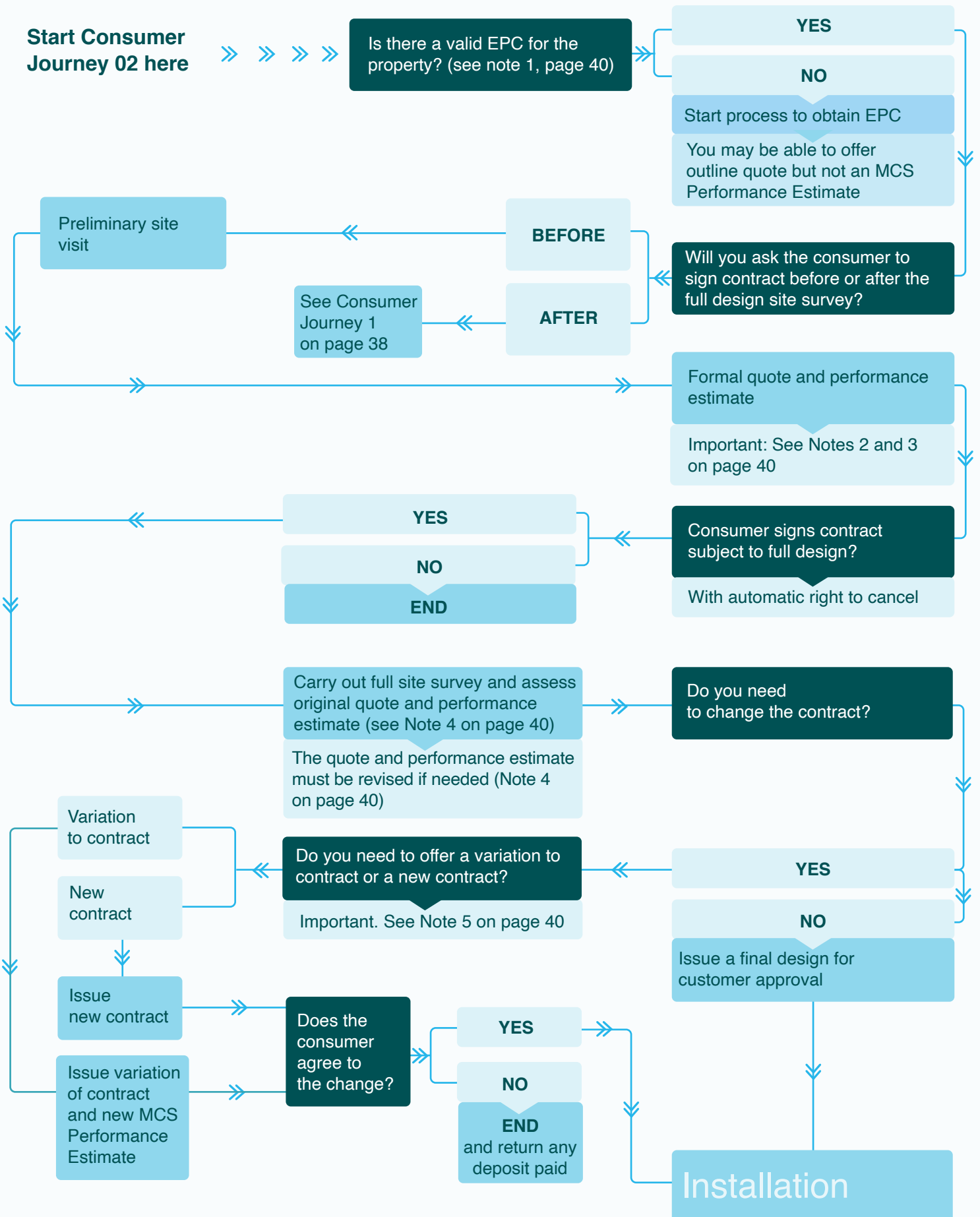

Notes relating to the consumer journeys

Example journeys are illustrative only. Other valid routes are possible if they comply with consumer law and industry rules.

Note 1

For RHI purposes, the EPC must be no older than two years and recommended work must be carried out.

Note 2

The MCS Heat Pump System Performance Estimate⁶.

Note 3

This MUST be consistent with the legal status of the sale - 'on' or 'off' premises.

See 3.0 The Right to Cancel on page 42

Note 4

The full site survey determines the emitters and may necessitate a revision of the whole design.

If either the HPSPE or the outline quote need to be revised, a variation of contract is essential.

Note 5

A new contract is required if the price changes or there is a substantive change to the design.

See 2.6 - The Variation to Contract on page 41

2.5 Journey Variations

Example:

- A variation to Consumer Journey 1 would be to commission the EPC and carry out the full room-by-room survey concurrently. Both would then be available at the same time for the preparation of a formal quote. This variation is not possible for Consumer Journey 2 because the EPC must be used to prepare the compulsory Heat Pump System Performance Estimate.
- Another variation on Consumer Journey 1 is that the installer can offer to provide a full survey service in return for a specified fee⁷. The installer can also provide a quote for the installation work at the same time and the consumer is free to use the survey to obtain further quotes from other companies.
- Similarly, the installer can also offer a system design service in addition to the full survey. It is common practice for an installer to waive the survey fee if the consumer decides to proceed with the installation with that installer.
- Other consumer journeys are possible but you should use this guidance to make sure the process you use complies with your Consumer Code and MIS 3005.

⁶ MIS 3005 Standard 4.2.16.

⁷ If the consumer chooses to pay for the survey and/or design then any charge must be made clear prior to the agreement, the charge must be reasonable and the consumer must be given a copy of the survey report.

2.6 The Variation to Contract

Agreeing contracts before the full design survey is carried out (see Consumer Journey 2 on page 39) obviously reduces the risk to the installer - because the work on the full house survey is not wasted if the consumer does not proceed with the agreement.

However, both you and the consumer must be aware that the design or price may need to be changed after the full design site survey. The full emitter selection and room-by-room heat loss must be carried out 'within a reasonable time frame'⁸, and if a change to the agreed design and/or estimated performance of the system (including but not limited to any financial projections) is needed, then the MCS Contractor must issue to the consumer:

- a variation to contract and an updated MCS Heat Pump System Performance Estimate; or
- a new contract (and new MCS Heat Pump System Performance Estimate).

Question: When do I use a variation to contract?

You should use a variation to contract if there is any change to the agreed design. Use the variation of contract to explain, for example, your revised choice of emitters and to obtain the consumer's permission for the design changes.

Such amendments may include (but are not limited to) the following:

- a change to the predicted number or size of emitters in some or all of the rooms;
- any change to the location of the main components;

- any change to the MCS Heat Pump System Performance Estimate such as flow temperature and Seasonal Coefficient of Performance (SCOP).

A model variation to contract for heat pump installations is available from the members' area of the RECC website. Other Consumer Codes may have an equivalent document available.

Question: When do I issue a new contract?

You must offer a new contract if the full design survey results in one or more of the following:

- a substantive change to the design which formed the basis of the original contract (such as a re-sized or different model of heat pump);
- an increase in the price of the installation as stated in the original quote; or
- a significant change in either the predicted savings on fuel expenditure or predicted RHI income.

Key point:
If you can't agree the terms of a variation to contract or new contract then the consumer may cancel the original contract without cost, obligation or liability. Any deposit paid must be returned in full⁹.

The consumer may be liable for the cost of the survey involved, but only if the consumer agreed to this cost (in writing) before that work was undertaken. If you do charge for the survey work, then the cost must be reasonable and a written survey report must be provided to the consumer¹⁰.

⁸ 4.2.17 of MIS 3005.

⁹ MIS 3005 Standard 4.2.18.

¹⁰ If the consumer chooses to pay for the survey and/or design then any charge must be made clear prior to the agreement, the charge must be reasonable and the consumer must be given a copy of the survey report.

3.0 The Right to Cancel

Summary – the consumer’s right to cancel

Getting it right. The rights consumers have in law to cancel contracts depend on ‘how’ and ‘where’ the contract is agreed. And these rights apply irrespective of whether the consumer agrees to the contract before or after the full design survey is completed. Getting it right for the process you deploy is critical because breaking the law on cancellation can be a criminal offence.

‘Off-premises’ contracts. A contract is defined as ‘off-premises’ if:

- it is agreed away from your own business premises (for example, in the consumer’s home) and you or your company’s sales agent is present at the time¹; or
- it is agreed by distance (for example, when the contract is negotiated by phone, post or over the internet) and there is no face-to-face discussion.

Your obligations. If you agree ‘off-premises’ or ‘distance’ contracts:

- A consumer can cancel the contract at any time after the contract is agreed and then at any time within the cancellation period which begins the day after the last equipment part relating to the contract is delivered to the consumer.
- You can start the installation work within the cancellation period provided your consumer has given express permission – in writing – for the work to start.

‘On-premises’ contracts. If you are sure that the contracts your company agrees with consumers are not ‘off-premises’ (or agreed by distance), then the strict cancellation rights

described above do not apply. However, you must comply with RECC and MCS requirements:

- RECC states that all consumers, irrespective of how or where the contract was agreed, must have a cancellation period of 14 days (starting when the contract is signed) within which they can cancel a contract without cost.
- Under the MCS Standard MIS 3005, consumers who agree contracts before the full survey is completed (Consumer Journey 2 on page 39) and who later cannot agree to the terms of any variation to contract can ‘cancel the existing contract without cost, obligation or liability.’
- Other CTSI Approved Codes may set out different cancellation periods. Check for details.

¹ A contract can also be defined as ‘off-premises’ if, after a home visit, a company pesters a customer to agree a contract. See 3.2 ‘Off-Premises’ selling on page 43.

3.1 Introduction

Getting the law right

The Consumer Contracts (Information, Cancellation and Additional Charges) Regulations 2013 (the CCRs) give consumers a legal right to cancel contracts they have agreed. These rights are important because they relate to both the consumer journeys described above. A failure to comply with these regulations can be a criminal offence.

But bear in mind that RECC and MCS have their own rules on cancellation that may go beyond the law. Under those rules (see 3.5 MCS and Consumer Codes - rules on cancellation on page 46) all consumers have cancellation rights, not just those agreeing contracts 'off-premises', or by 'distance.'

3.2 'Off-premises' selling

'Off-premises' sales occur when:

- the contract is agreed away from your own business premises; and
- you (or anyone from your company) is present at the time.

Or:

- it is agreed by distance (for example, when the contract is negotiated by phone, post or over the internet) and there is no face-to-face discussion.

However, this law may still apply if a sales agent (or anyone from your company) makes a home visit and leaves the quote/contract with the consumer to consider but then pesters them for a decision.

Where agreements are defined as 'off-premises' or 'distance' contracts then:

- Consumers must be given very specific information about your business and about the sale before the contract is agreed (See 4.1 Introduction on page 48). This includes detailed information on how they can cancel and, if you seek permission to start work before the end of the cancellation period, you must state that they will incur costs for services carried out up to the point of cancellation. (For more on the information you must provide, see 3.3 'Off-premises' selling and starting work before the end of the cancellation period, page 44).
- When the contract relates to the delivery of equipment for installation (as is normally the case for microgeneration), then the 14-day cancellation period starts on the day after the last equipment part relating to the contract is delivered to the customer and the consumer can cancel at any time up to the time of delivery.
- Traders must refund within 14 days of cancellation of a service contract or the receipt of goods (or of evidence of the consumer returning them).
- Where the consumer cancels a contract, any ancillary contract (such as a warranty or credit agreement) is automatically cancelled.

Scenario based guidance to the CCRs is available from the members' area of the RECC website.

You must provide a notice of a right to cancel and it must be exactly in line with Schedule 3 of the Consumer Contracts (Information, Cancellation and Additional Charges) Regulations 2013⁴.

A compliant form is available from the RECC website. This can be seen in the model documents in the members' section.

3.3 'Off-premises' selling and starting work before the end of the cancellation period

Key point:

The regulations do allow you to start the installation work within the cancellation period provided your consumer has given express permission in writing for the work to start. When this happens your consumer does not 'waive' the right to cancel. They can still cancel the contract even if they give permission for the work to start. However, if they do cancel, you can recover costs incurred.

Starting work before the end of the 14-day cancellation period ('off-premises' and distance contracts)

The express request

Under the law, permission to start work is called the 'express request' and is defined as a letter or email (or a request made on some other 'durable medium'). Any form you provide must be physically separate from the printed contract or order form. It can be a pre-printed form but it must include a signature box for the consumer to sign.

Additionally, the express request form must also state that if the consumer later decides to cancel the contract within the cancellation time they may incur costs for any work undertaken during that time.

Warning: Starting work without written agreement

A few microgeneration companies have routinely started installation work within the cancellation period 'at their own risk' - without express consent from the consumer. This is not a valid business model and companies doing this are in breach of the legislation⁵. Installation work without consent puts pressure on consumers not to cancel and is not allowed under any circumstances.

When your consumer signs an express request for the installation work to start within the cancellation period the consumer still has the right to cancel. However, you are entitled to charge your consumer for the work completed up to the point when the cancellation is made. What should be paid will be in proportion to what has been carried out in comparison with the full contract price.

Scenario:

A cancellation after work has started

Mr Smith has signed a contract for a ground source heat pump system and has signed an 'express request' form for the work to start before the end of the cancellation period. Your company starts the necessary ground works. Unfortunately, Mr Smith's circumstances change and he says he must sell his property. He must cancel the contract and he has a right to do so. However, under the legislation, you can recover the reasonable costs you have already incurred.

⁴ <https://www.legislation.gov.uk/uksi/2013/3134/schedule/3/made>

⁵ <http://www.legislation.gov.uk/uksi/2013/3134/regulation/36/made>

Under 36(2) of the legislation, the consumer loses the right to cancel the contract within the cancellation period when the installation is completely finished. The company can charge the full contract price when this occurs.

‘Off-premises’ Selling and Consumer Journey 1 (contracts agreed after survey):

The way the CCRs relate to Consumer Journey 1 is straightforward. As detailed above, the mandatory 14-day cancellation period starts on the day after the goods come into the physical possession of the consumer. Consumers can also cancel at any point prior to delivery. You can start the installation work before the end of the cancellation period provided your customer has given you ‘express consent’ in writing to do so.

‘Off-premises’ Selling and Consumer Journey 2 (contracts agreed before survey):

As contracts agreed before the survey may need to be amended (using either a variation of contract or an entirely new contract) the way the CCRs interacts with this consumer journey can be confusing. The following clarifications should help:

- The consumer can cancel the contract agreement as soon as it is signed. This means that you need express permission from the consumer to carry out any chargeable work during the 14-day cancellation period. This is important because if you carry out any work (such as the full survey) without express consent during the cancellation period and the consumer later cancels, you will not be able to charge for that work.
- Secondly, the cancellation period will be ‘re-set’ after the survey when the terms of the contract are clear.
- If a new contract is needed then the new cancellation period will depend on how that new contract is agreed.
- If the consumer decides to proceed with the contract or a variation to contract then their cancellation rights remain unchanged – they will be able to cancel at any time up to the start of the cancellation period which begins the day the last equipment part relating to the contract is delivered to the consumer.

3.4 'On-premises' selling

'On-premises' contracts are defined simply as those contracts between traders and consumers that are neither 'distance' contracts nor 'off-premises' contracts.

Scenario: Typical 'on-premises' selling

Mrs Brown asks you to visit her home to explain the air source heat pump system you offer. You discuss the system, where it can be installed and a possible contract. You leave a quote with an agreement form for her to examine in her own time. If Mrs Brown later signs the agreement then this would be defined as an 'on-premises' contract (provided your company did not pester Mrs Brown for a signature in any way).

If you are sure that the contracts your company agrees with consumers are 'on-premises' contracts, then the strict cancellation rights as set out above for 'off-premises' sales do not apply. However, the regulations set out the specific information that you must provide before the contract is agreed. This includes information about your business and about the sale (see 4.0 The information you must provide on page 47).

You must also comply with the CTSI Approved Consumer Code rules on cancellation described below.

3.5 MCS and Consumer Codes - rules on cancellation

The RECC rules on cancellation are simple:

- RECC states that all consumers must have a cancellation period of 14 days within which they can cancel a contract without cost.
- Other CTSI Approved Codes have their own cancellation periods. Check for details.
- As explained on page 45, contracts agreed before the survey may need to be amended (using a variation to contract) after the full survey is available. Where a company and a consumer cannot reach an agreement on such a variation to contract, as outlined in 2.4 Consumer Journey 2 on page 39, then 'the customer may cancel the existing contract without cost, obligation or liability' (see 4.2.18 of MIS 3005).

4.0 The information you must provide

Summary – what you must give consumers under the law and under industry rules

The information you must provide by law. By law all MCS Contractors must give consumers very specific information before any contract is agreed. Contractors who agree ‘off-premises’ sales must provide additional information (see 4.2 Information you must provide on page 48).

The information you must provide under the Consumer Codes. The Renewable Energy Consumer Code (RECC) details the information you must provide and, by complying with RECC, you will almost certainly be complying with the law.

The information you must provide under MCS. The technology Standard MIS 3005 for heat pumps identifies information that must be given to the consumer by the installer (see Appendix 3 on page 76 for a full list). For example, you must provide:

- The completed MCS Heat Pump System Performance Estimate.
- All information related to any permissions, approvals and licences that may be required¹.

Other information you may need to provide. The law prohibits ‘misleading omissions’ and this is why RECC sets out specific obligations about the information you should give consumers before the contract is agreed (the other Consumer Codes may also have similar rules).

For example, it may be essential in law to provide extra information such as:

- any costs associated with the generating system over and above that set out in the quote; and
- any additional monitoring or metering services the consumer will be expected to pay for.

See 4.3 Information you must provide under Consumer Codes on page 49 for more on this.

Permissions. Both MCS and RECC have rules about the provision of information on permissions, approvals and licences that may be needed for an installation. Although planning permission and/or building control are not normally needed for air source heat pumps (following compliance with a noise assessment e.g. MCS 020, and maximum outdoor unit volume) or ground source heat pumps, the rules do vary throughout the UK. See 4.6 Permissions on page 51 for more on this.

Incentives. If you make the claim that consumers will be able to benefit from the RHI then you must make sure that the installation proposal meets the RHI eligibility criteria that are your responsibility. You must also pass that information on to consumers in the correct way.

¹ MIS 3005 Standard 4.4.2

4.1 Introduction

MCS Contractors give consumers two types of information:

- this section will cover the information you must give consumers under the law and under industry rules; and
- Section 5.0 will examine the laws and rules that cover the information you choose to provide consumers in the form of, for example, advertising and performance claims.

Tip: While compliance with the law and industry rules is always the direct responsibility of the MCS Contractor, RECC provides 'model' documents that offer guidance and help in compliance with, for example, your legal obligations and industry sector issues such as Ofgem rules on the RHI and MCS requirements. These 'models' can be adapted and tailored to suit your own business. Other Consumer Codes may have equivalent models available.

4.2 Information you must provide in law

Under the law all MCS Contractors must give consumers very specific information. In some cases, and as described in 3.2 above, a failure to provide the information may be a criminal offence². This material you must provide in law is in addition to that described in 3.0 regarding the information about cancellation terms for sales agreed.

See Appendix 1 ('off-premises' contracts) and Appendix 2 ('on-premises' contracts) on page 75 for a full list of information that must be made available (where applicable).

Any failure to provide the information may be a breach of contract. Equally, and as described in 5.4.1 below, if any of the information is wrong, then your customer may be able to claim a breach of contract under the Consumer Rights Act 2015³.

² The Consumer Contracts (Information, Cancellation and Additional Charges) 2013 (the CCRs): <http://www.legislation.gov.uk/uksl/2013/3134/contents/made>
³ <https://www.businesscompanion.info/en/quick-guides/services/the-supply-of-services>

4.3 Information you must provide under the Consumer Codes

RECC deciphers the law for the microgeneration sector by detailing the information and documents you must give to consumers before they sign any agreement.

Most of the information represents common sense, however in some areas and for some installers those requirements go beyond the law. By complying with RECC, you will almost certainly be complying with the law (for both 'on' and 'off-premises' contracts).

Pre-Contractual Information

Both the law and RECC recognise that this basic information can be provided in a variety of ways such as the quote or the contract terms⁴.

You must also include information about the complaints process and, where relevant, information on the need for regular servicing and fuel requirements.

Quotes

The information you should include in your quotes is outlined by 5.4.2 of the RECC Consumer Code⁵.

Terms of business

You must also provide clear and unambiguous contract terms. This is covered by chapters 6.0 and 7.0 of the RECC Consumer Code⁶.

If in doubt about the basic information you must provide in law, see Appendix 1 and Appendix 2 on page 75.

⁴<https://www.recc.org.uk/scheme/consumercode#tag5.6>

⁵<https://www.recc.org.uk/scheme/consumercode#tag5.4>

⁶<http://www.recc.org.uk/scheme/consumer-code#tag6> for more information

4.4 Information you must provide under MCS

The MCS technology Standard MIS 3005 for Heat Pumps identifies information that must be given to the consumer by the installer (see Appendix 3 on page 76 for a full list). Some of that information must form part of your contract agreement. For example, you must provide:

- The completed MCS Heat Pump System Performance Estimate document described in Part 3 of this guidance. This includes the formal MCS Disclaimer statement (see 7.2 The MCS Performance Disclaimer on page 65).
- An explanation of the cost and benefits of achieving a higher SCOP/Seasonal Primary Energy Ratio (SPER) using the graph on the MCS Heat Pump System Performance Estimate and an explanation (either verbally or in writing) of how the flow temperature affects the efficiency of system performance and the impact this may have on the running cost.
- For Consumer Journey 1 (see page 38) the full heat loss and room-by-room site survey, as described in MIS 3005, including all room heat losses and proposed emitters⁷. The full survey can be provided after the contract agreement see 2.4 Consumer Journey 2 on page 37.
- If you provide any other additional performance estimates using an alternative methodology – a note stating it should be treated with caution (see 5.3 Getting performance claims right: What the law, MCS and the Consumer Codes say about performance claims on page 53).
- All information related to any permissions, approvals and licences that may be required⁸. This is also a requirement under RECC (see 4.6 Permissions on page 51).

4.5 Other information the consumer needs to know

The law prohibits misleading omissions therefore you need to provide all important information related to the installation; in particular, about any costs associated with the generating system over and above that laid out in the quote. This is why RECC sets out specific obligations about the information you should give consumers before the contract is agreed (the other Consumer Codes may also have similar rules).

For example, it may be essential in law to provide detail about the circumstances that may result in extra chargeable work and accurate information on any ancillary costs including the cost of replacement parts (if needed recurrently) and essential servicing.

RECC currently requires members to provide accurate information about any permissions needed (see 4.6 Permissions on page 51) and to provide information about incentive schemes available such as the RHI and agree with the consumer whose responsibility it will be to apply (see 4.7 Incentives on page 51).

Please note:

Strict rules apply in situations where the consumer assigns rights to government incentive payments^{9,10}.

⁷ MIS 3005 4.2.17

⁸ MIS 3005 4.4.2

⁹ Renewable Energy Consumer Code 5.5.3 - <https://www.recc.org.uk/scheme/consumer-code#tag5.5>

¹⁰ Ofgem guidance on Assignment of Rights - <https://www.ofgem.gov.uk/key-term-explained/assignment-rights>

4.6 Permissions

MCS and RECC state that Contractors must make consumers aware of all permissions, approvals and licences needed¹¹. Although planning permission and/or building control are not normally needed for air source heat pumps (following compliance with a noise assessment e.g. MCS 020, and maximum outdoor unit volume) or ground source heat pumps, this does vary throughout the UK and careful assessment of the rules is required. RECC members must agree with the consumer whose responsibility it will be to apply for any permissions needed.

The RECC model contract 'Cover Letter' details the planning/building permissions necessary in each of the UK home nations with references to official planning information where needed¹². The other CTSI Consumer Codes may have similar information available.

According to Ofgem, consumers should also seek permission for heat pump installation from the local electricity Distribution Network Operator (DNO) and you should tell them about the need for this permission before the contract is signed. See the Ofgem RHI Essential Guide for Installers for more information¹³.

4.7 Incentives

It is obviously good practice for MCS Contractors to help consumers understand and apply for relevant financial incentive schemes such as the RHI. Ofgem also expects installers to give consumers support with the RHI process¹⁴.

Installers who use an incentive scheme (such as the RHI) to promote their service have a clear obligation to make sure the installation proposal meets the scheme eligibility criteria that falls under their responsibility. That installer must also pass that information on to the consumer in the correct way.

The consumer will also need essential information from you about their installation so they can make sense of the proposal and make a successful RHI application. That information is set out in the technology criteria in the Ofgem RHI Essential Guide for Installers¹⁵. Some consumers may need additional information on, for example, the need for compulsory metering for payment¹⁶.

¹¹ Paragraph 4.4.2 of MIS 3005

¹² See the RECC Model Cover Letter for more: <https://www.recc.org.uk/member>

¹³ <https://www.ofgem.gov.uk/publications-and-updates/domestic-renewable-heat-incentive-essential-guide-installers> Section 3

¹⁴ <https://www.ofgem.gov.uk/publications-and-updates/domestic-renewable-heat-incentive-essential-guide-installers> Section 10

¹⁵ <https://www.ofgem.gov.uk/publications-and-updates/domestic-renewable-heat-incentive-essential-guide-installers> Section 3 and Section 4

¹⁶ <https://www.ofgem.gov.uk/publications-and-updates/domestic-renewable-heat-incentive-essential-guide-installers> Section 7

5.0 The information you choose to provide

Summary - What you need to know about performance claims and marketing

Your claims can form part of the contract.

Essentially, all the claims you make about the things you sell can form part of your contract with the consumer. If those claims are wrong or misleading you can be in breach of contract and consumers can seek redress. Furthermore, breaking provisions in the Consumer Protection from Unfair Trading Regulations (the CPRs; the law that underpins honest marketing and selling) is a criminal offence¹.

The Advertising CAP Codes: MCS Contractors are free to supply any technical, marketing and performance information they wish – provided it is legal and, where relevant, complies with the central principle of the Advertising Standards Authority's CAP Codes²: that all marketing should also be decent, honest and truthful³. It is essential that you comply with the CAP Codes.

MCS rules on additional performance claims:

Under the MCS Standard MIS 3005 (4.3.4), any performance estimate you give, in addition to the MCS Heat Pump System Performance Estimate:

- must not be given greater prominence than the MCS Heat Pump System Performance Estimate;
- must carry a warning that it should be treated with caution (see 4.4 Information you must provide under MCS on page 50).

Telephone Preference Service (TPS), the Mailing Preference Service (MPS): Under RECC you must use the TPS and MPS schemes and have any telemarketing certified by the TPS Assured service.

The law and aggressive sales practices.

The law prohibits aggressive sales techniques that use harassment, coercion or undue influence. For example, staying in a consumer's home for too long in order put pressure on the customer to sign a contract (see 5.4.2 The Consumer Protection from Unfair Trading Regulations 2008 (the CPRs) on page 58).

The law and unfair commercial practices.

The law prohibits 31 specific commercial practices that are always considered unfair. For example, falsely claiming a discount is only available for a very limited time (see 5.4.2 The Consumer Protection from Unfair Trading Regulations 2008 (the CPRs) on page 58).

¹ <https://www.businesscompanion.info/en/quick-guides/goods/consumer-protection-from-unfair-trading>

² The Committees of Advertising Practice (CAP) Codes: <https://www.asa.org.uk/>

³ <https://www.asa.org.uk/uploads/assets/uploaded/db4d66de-e5da-4509-a4c626ed15c6f00c.pdf> - the CAP Code.

5.1 Introduction

This section briefly describes the most relevant parts of the UK Code of Non-broadcast Advertising, Sales Promotion and Marketing (CAP Codes). It will also highlight what you need to know about the law as it relates to the sale of heat pump installations, as well as technical and financial performance claims.

Tip: More than 200 separate laws and regulations affect marketing and advertising practices in the UK. Even so, complying with the law is relatively straightforward. As long as your marketing conforms to the CAP Codes, then your marketing should be legally sound.

5.2 Complying with the advertising codes of practice

The UK Code of Broadcast Advertising (BCAP Code) and the CAP Code aim to:

- protect consumers from misleading marketing; and
- ensure fair competition between businesses.

RECC members must comply with the CAP codes.

The CAP Codes are important not only because they contain rules that are not included in law but because companies that do not comply with the ASA Codes can be subject to severe sanction and adverse publicity.

The ASA is an independent regulator and can impose pre-vetting of advertising and refer non-compliant businesses to Trading Standards for legal action. It is essential that you comply with the CAP Codes.

The sections of the CAP Code that are most relevant to MCS Contractors are described in Appendix 4.

5.3 Getting performance claims right: what the law, MCS and the Consumer Codes say about performance claims

Under the heat pumps technical Standard MIS 3005, if you provide any estimate of performance – in addition to the compulsory Heat Pump System Performance Estimate – then it must:

- describe and justify the methodology and factors used (if different from the MCS performance estimate approach); and
- be accompanied with an associated warning that it should be treated with caution; and
- not be given greater prominence than the MCS Heat Pump System Performance Estimate⁴.

Under RECC you must at least:

- comply with the CAP Codes (see 5.2 Complying with the advertising codes of practice on page 53) and, in particular, make sure that performance claims in advertising are attributed to a reputable source (see 5.3.1 Performance claims - Avoiding misleading and exaggerated performance information on page 54).

A full list of member requirements can be found in the RECC Consumer Code⁵.

Please also note that RECC members must:

- use the Telephone Preference Service (TPS) and the Mailing Preference Service (MPS); and
- comply with the TPS Assured's guidance on telemarketing⁶.

⁴ MCS MIS 3005 paragraph 4.3.4

⁵ RECC consumer code - <https://www.recc.org.uk/scheme/consumer-code#tag5>

⁶ <http://www.tpsassured.co.uk>

5.3.1 Performance Claims -

Avoiding misleading and exaggerated performance information

Section 4.0 The information you must provide on page 47 of this guide covers the compulsory information you must give to consumers (including the MCS Heat Pump System Performance Estimate). The information below covers all other claims you may make about the technical and financial performance of the proposed installation.

Heat pump installers have an obligation in law to avoid using misleading or exaggerated performance figures. Claims that include significant errors risk bringing the industry into disrepute. The claims you make about the service you provide must be true. These legal obligations are described briefly in 5.4 What the law says about the information you provide on page 58.

Performance claims may be extrapolated from the formal Heat Pump System Performance Estimate or may be based on some other methodology used to produce an 'alternative performance estimate' as described in 5.3 Getting performance claims right: what the law, MCS and the Consumer Codes say about performance claims on page 53.

It is important that you are cautious about the performance claims you make. The following factors are critical when you detail performance claims:

1. The claims you make must be true.
2. The SCOP efficiency value is based on factory-based product testing. The SCOP efficiency prediction will differ from the actual performance achieved by the heat pump when installed within the context of a heat generating

system. It is therefore inevitable that the actual efficiency achieved will be less than the SCOP prediction.

3. You must understand your consumer's objectives. While many heat pumps are installed as a means to reduce carbon output, incentives such as the RHI are also being promoted to reduce energy costs. Caution is always critical when the customer's main objective is saving money on fuel and/or a clear payback⁸. Heat pumps may not be viable at all in these scenarios. See 5.3.2 Performance Claims - The need for caution on page 55 for more on this.
4. Performance claims and the financial consequences that flow from them can never be certain. While you may be able to give a reasonable prediction of likely RHI income, fuel savings are impossible to forecast over time. The formal MCS disclaimer (on the Heat Pump System Performance Estimate) cannot be used to:
 - disown the level of performance claimed that formed the basis of the sale;
 - justify claims that are calculated without reasonable skill and care; or
 - seek to evade responsibility for any wider claims made about performance issues.

For more detail on the disclaimer see 7.2 The MCS Performance Disclaimer on page 65.

⁸ More ASHP installations replace oil and gas (combined) than electricity. <https://www.gov.uk/government/statistics/rhi-deployment-data-march-2018-table-2.4>

5.3.2 Performance Claims - The need for caution

Given the information in 5.3.1 Performance Claims - Avoiding misleading and exaggerated performance information, installers should always exercise care with performance claims they make and should exercise extreme caution when:

1. Offering proposals that indicate marginal financial benefit. For example, where a formal performance estimate indicates a possible annual fuel saving of less than 20% and the consumer's main objective is financial benefit, then the proposal may not be viable in the current circumstances because the RHI income and savings may not match the cost of the installation during the lifetime of the heat pump. If you offer any indication of a viable 'payback' then all significant uncertainties (such as those related to fuel inflation) must be explained.
2. The consumer's key objective is financial benefit. As the exact financial consequences are not definite, installers cannot make firm predictions. The uncertainties involved in performance prediction should be made clear.

3. The installation will displace oil or gas. Heat pumps replace more gas and oil boilers (combined) than electric heating systems. In many cases there may be little or no financial benefit. You must be able to justify any claims you make about fuel savings.

Please note:

It is always good practice to double-check heat pump performance estimates using available resources. One available resource is the BRE website, which graphically presents DAHPSE (Domestic Annual Heat Pump Seasonal Efficiency) estimates of performance in accordance with the SPF_H4 system boundary⁹.

To calculate these estimates the DAHPSE method uses an annual combined space and hot water heating duty cycle, which incorporates hourly space and hot water heat load and temperature assumptions, using average UK weather data (taken as City of Leeds). Heat pump test data satisfying Ecodesign regulation requirements (EN14825:2016) is used as an input to the calculation.

Efficiency estimates are held in the Product Characteristics Database (PCDB) when a heat pump is submitted for entry by manufacturers. There are up to 72 Annual Efficiency values held in the PCDB for submitted heat pumps, each with different system installation configurations (plant size ratio, design flow temperature, weather compensation presence). These values are also used by the UK's National Calculation Methodology for energy rating of dwellings (SAP).

Performance estimates are generally poorer than SCOP values due to a number of reasons, including the impact of providing a hot water service, which is not considered by the SCOP calculation.

⁹ <https://www.bre.co.uk/heatpumpefficiency/background>

The following scenarios illustrate why caution and care are essential. All of the following scenarios are based on actual estimates examined by RECC:

Unacceptable Performance Forecasting - actual values presented in performance claims				
		Scenario 1	Scenario 2	Scenario 3
Total Overall household demand as in EPC	kWh	16400	18300	13200
% Space Heating Supplied by HP	%	100	75	100
% Water Heating Supplied by HP	%	100	0	100
SCOP		3.8	4.1	3.25
Heat Supplied by HP	kWh		13725	
Estimate of Energy Needed to run Pump	kWh		3347	
Estimate of Current Fuel Cost (before install)	£	£895	£915	
Estimate of Future Fuel Cost (after install)	£	£561 (@13ppkWh)	£435	
Estimate of annual savings	£	£334	£480	
Total RHI Income per annum for 7 years only	£		£1,056	£930
Total annual income and savings (combined for 7 years)	£		£1,536	
Install Cost	£	£11,000	£12,000	£10,500
Payback Claimed	Years	7	10	12

Scenario 1: Misleading Comparisons

ASHP replacing gas at 3.6ppkWh.

In this scenario the installer based the predicted fuel costs on the total demand taken from the EPC but based the 'current fuel costs' on the installer's own higher estimate of demand at 19,900kWh. This significantly inflated the current fuel costs in comparison with predicted fuel costs and exaggerated potential savings. In fact, on a like-for-like basis the current fuel costs should have been £738 (assuming gas boiler efficiency of 80%), and annual savings of around £170 per annum. The installer predicted a payback of 7 years but a total RHI income and savings of £9849 over 7 years would leave a shortfall of more than £1100 on the installation cost. Any payback would more likely occur after 12 years or more.

Scenario 2: Underestimate of future fuel costs

Hybrid ASHP partial replacement of gas at 4ppkWh.

This proposal was a hybrid heat pump providing 75% of annual space heating demand. The installer calculated current fuel spend at around £900 (including allowance for gas boiler efficiency at 80%). The future spend on fuel was predicted to be £435 but this failed to include at least £250 for the additional heating necessary and hot water. As the actual future fuel costs would be more than £650, the annual savings would more likely be around £230 per annum. The installer predicted a payback of 10 years but the actual RHI income and savings would total £9000 over 7 years leaving a shortfall of £3000 on the installation cost. This installation would be at risk of failing to reach a payback within the lifetime of the heat pump.

Please note:

The installer's calculation of current fuel costs also makes an allowance for gas boiler efficiency.

Scenario 3: Misleading Assumptions

These were the only values presented as the formal performance estimate proposal for an ASHP to replace oil at a current fuel cost of 4.25ppkWh. The installer claimed a financial payback of 12 years. However, as the annual RHI income is £930, the total RHI income over 7 years is £6510. This means the consumer would need to generate fuel savings of at least £330 per year to achieve the claimed payback of 12 years. In fact, assuming an electricity price of 13ppkWh, the consumer would be unlikely to save more than £180 per year. This installation would be at risk of failing to reach a payback within the lifetime of the heat pump.

Please note:

Scenario 3 includes an allowance for an oil boiler efficiency of 80%.

Also, the comments about payback assume the SCOPs quoted by the installer accurately predict the SPFs that will be achieved when installed within the context of the full heat generating system. In reality, the SPFs achieved would almost certainly be lower.

Scenario 4 – Speculative forecasts

Crude ‘financial forecasts’ or ‘return on investment’ projections can be extremely misleading. The example below was used by an installer as part of a quote for a ASHP to replace electric heating.

Potentially misleading financial projections

Year	Current Heating Cost	Potential Heating Cost	Fuel Saving	RHI	Cumulative Fuel Saving	Cumulative Benefit 7 Years
1	£2,240	£639	£1,601	£1,169	£1,601	
2	£2,464	£703	£1,761	£1,198	£3,362	
3	£2,710	£773	£1,937	£1,228	£5,299	
4	£2,981	£851	£2,131	£1,259	£7,430	
5	£3,280	£936	£2,344	£1,290	£9,774	
6	£3,608	£1,029	£2,578	£1,323	£1,2353	
7	£3,968	£1,132	£2,836	£1,356	£15,189	
				£8,823		£24,012
	Fuel Inflation	10%				
	General Inflation	2.50%				

Energy ‘fuel inflation’ was included at 10% and projected over 20 years. This table indicates the cumulative fuel saving over 7 years as £15,189. Combined with the RHI, the 7-year cumulative benefit indicated was £24,012. All of the figures were based on an assumed SCOP of 3.5.

The figures were based on supposition about fuel inflation but this was not made clear. Forecasts like these will always compound any errors and any overestimate of performance in the SCOP calculation.

5.4 What the law says about the information you choose to provide

Tip: The CAP Codes refer only to marketing. The relevant laws relate to all the information you make available – even the verbal statements made by you or your company’s representatives can form part of the binding contract.

The Consumer Protection from Unfair Trading Regulations 2008 (CPRs) and the Consumer Rights Act 2015 are both critical when thinking about what information you choose to provide.

5.4.1 The Consumer Rights Act 2015 (CRA)

The CRA states that:

- the goods you supply must meet the description given to them; and
- if you make claims about your business or your service then those claims must be true.

Any verbal or written statement about your business or your service that you provide before the contract is signed falls within the scope of the Act. This is important because any misleading or incorrect statement (that a consumer relies on when agreeing the contract) is now a contractual term and consumers have the right to raise a breach of contract against the company to resolve the issue.

There are obviously good reasons why contract agreements for high value installation services may need to be revised, but this is normally only possible if both parties are in agreement (or if the contract is explicit about exactly what

changes are allowed). For example, if you offer a performance estimate and then, after a survey, you need to correct the estimate with the consumer’s consent (see Consumer Journey 2 on page 39).

Warning: You have to get this information right. The CRA changed a fundamental aspect of consumer law. You can choose to provide your consumers with all kinds of information. For example, brochures, additional performance information, or claims about carbon management. However, if the consumer relies on any of that information (about you or your service) when deciding to enter the contract then that information will form part of the binding contract. This applies to both written and verbal claims¹⁰.

5.4.2 The Consumer Protection from Unfair Trading Regulations 2008 (the CPRs)

These regulations ban ‘unfair commercial practices’ that:

- can mislead consumers by containing false or deceptive information or if the overall presentation of the information deceives or is likely to deceive consumers; and/or
- can mislead by omission – for example, by omitting ‘material information’ that would cause, or would be likely to cause, the average consumer to take a different transactional decision. ‘Material information’ means any information that the consumer needs to make an informed decision.

¹⁰ <https://www.businesscompanion.info/en/quick-guides/services/the-supply-of-services>

The law also prohibits aggressive sales techniques that use harassment, coercion or undue influence. Specific home selling techniques occasionally seen in microgeneration are likely to contravene the CPRs and risk bringing the industry into disrepute. Those techniques include:

- staying in the consumer's premises for an unreasonable length of time in order to put pressure on the consumer to sign a contract;
- offering an artificially high initial price followed by a discount;
- withholding price information; and
- offering a discount for signing at the time of a sales visit.

The CPRs also ban 31 specific commercial practices that are always considered to be unfair and several of these banned practices are also relevant to the microgeneration sector. It is good practice to provide training for employees and sales agents to make sure banned tactics are never used¹¹.

The banned practices include:

- falsely claiming that a product or discount is only available for a very limited time in order to put pressure on a consumer to make a quick decision;
- staying in a consumer's home and ignoring requests to leave;
- pestering customers by phone, fax or e-mail; and,
- using aggressive sales tactics when home selling.

For more information see the full list of banned practices: <http://www.legislation.gov.uk/ukxi/2008/1277/schedule/1/made>

Warning: Misleading claims by manufacturers

If your consumer makes a purchase decision about a product or service based on a misleading statement by the manufacturer then you may be liable.

This is certainly a risk if you repeat a misleading claim by a manufacturer.

For example, if a manufacturer claims a specific heat pump has a 'coefficient of performance' of 5 and you imply this performance is normal then your consumer may have a claim against you if:

- they can show that they relied on that information;
- it is clear the heat pump would not achieve that level of performance in the consumer's home.

¹¹ See the RECC Training Pages for more information. The other Consumer Codes may also have training available

6.0 Unfair Contracts

Summary – getting the terms and conditions right

Why contract terms are important. A clear and fair contract minimises the chance of a dispute. This is particularly important when the service involves complex goods and services such as home installation.

It is crucial to get your contract terms right because your consumers cannot be bound by terms that are ‘unfair’ in law.

Good contracts protect you. Contracts should protect your business because they should spell out the consumer’s obligations clearly (what they will do for you) and should describe your obligations (what you will do for the consumer).

What ‘terms’ are involved? As explained in 5.4.1 The Consumer Rights Act 2015 (CRA) on page 58, the contract terms are not only those in the ‘terms and conditions’ document. Any information you give a consumer can be binding if they rely on it when agreeing the contract.

Unfair clauses are damaging. While unfair contract terms are not legally binding, they can be misleading. For example, an unfair clause may convince a consumer that they have no legal rights to unwind a contract when, in fact, they do. If you are in a dispute, the court will test your contract for fairness, even if ‘fairness’ in law is not the subject of dispute.

What is an unfair contract term? Under the law a range of contract terms are simply unenforceable and must not be used. These ‘blacklisted’ terms include, for example, terms an installer may use to evade their legal responsibilities. A range of other unfair terms are described in 7.0 Unacceptable terms in microgeneration contracts on page 64.

Model contracts. RECC has a ‘model’ consumer ‘terms and conditions’ contract available which you can use to ensure your terms are fair. Other Consumer Codes may have an equivalent model available.

6.1 Introduction

This chapter details when contracts are binding and how they can be used to protect both yourself and the consumer. It also shows why it is important to get contract terms correct, what 'unfair' terms are and why they are damaging.

6.2 When is a contract binding?

There is considerable confusion among installers about the 'terms and conditions' document in domestic contracts. For example, some companies think contract terms are final and binding as long as the consumer signs¹. This is a misunderstanding.

In fact, businesses can't enforce contract terms that are unfair in law. 'Unfairness' can take many forms and the law bans a range of specific terms and sets out clearly how many others can be potentially unfair (see 6.4 What is an 'unfair' contract term? on page 62 and 7.0 Unacceptable terms in microgeneration contracts on page 64). Many of those terms are frequently seen in contracts for heat pumps. Unfair terms represent bad practice and risk bringing the industry into disrepute.

It is also important to note that if you are in a dispute with a consumer about any issue covered by a contract term then the court will test your terms for fairness even if that is not the subject of the dispute².

Warning: Contract terms are not binding if they are unfair.

Scenario:

Three months after a heat pump installation, Mr Green complains to his MCS Contractor because his system is not working properly. The MCS Contractor says the problem is due to a manufacturing fault in the heat pump and it needs to be replaced. Mr Green wants the work carried out immediately but the installer points to a contract term which states that major components will only be replaced if the installer can make a successful claim against the relevant manufacturer and this may take several weeks. A severe dispute arises.

In fact there should be no dispute. Such a clause would be unfair in law and would not be binding. The consumer would have a legal right to a repair or replacement.

¹ <https://www.gov.uk/government/news/over-half-of-businesses-dont-know-unfair-contract-rules-well>

² <http://www.legislation.gov.uk/ukpga/2015/15/section/71> : "the court must consider whether the term is fair even if none of the parties to the proceedings has raised that issue or indicated that it intends to raise it."

6.3 Contracts protect you

Contracts should protect your business because they should spell out the consumer's obligations and your obligations clearly. Contract terms should seek to clarify the terms of the purchase. But remember – contract terms only protect you if they are 'fair'.

Example:

In many microgeneration installations it is important that customers finish any preparatory work on their property before the installation can proceed to the timetable indicated by the installer. This is an important obligation on consumers and should be a key term in many contracts. The contract should explain the importance of this work, and make clear to the consumer that they may have to pay reasonable costs for delays if this work is not completed by an agreed date. If you don't make this obligation clear to consumers (and fair), you may find it difficult to resolve disputes about the preparatory work and it may be much harder to claim reasonable compensation if you need to.

The term may be 'unfair' in law if it refers to an amount of compensation that is excessive. Any compensation would have to reflect actual losses incurred.

6.4 What is an 'unfair' contract term?

'Blacklisted' terms

The law renders a range of contract terms legally ineffective. These are described as 'blacklisted' and include, for example:

- terms that seek to exclude or restrict liability for death or personal injury resulting from negligence;
- terms used by an installer to evade their legal responsibilities – including the Consumer Rights Act; such as their obligations:
 - to ensure that products are of a satisfactory quality; and
 - services are provided with reasonable care.

For more information on blacklisted terms please refer to the government guidance on writing fair contracts³.

³<https://www.gov.uk/government/collections/writing-fair-contracts-guidance-for-businesses#guidance>

Grey List terms

Aside from blacklisted terms that are always unfair, the law clearly describes a range of other terms that are potentially unfair. Those are identified in the 'Grey List'; terms that may be unfair depending on the circumstances.

Terms are found unfair if they fail the 'fairness test'. Such terms (or set of terms) create an imbalance to the potential detriment of the consumer and clear examples would be:

- a term that states the trader has a right to final decision as to whether the goods or the service conform with the contract;
- a term that states the company can decide whether a consumer's complaint is valid; and,
- a term that imposes harsh financial penalties for breaches of contract (such as late payment).

Another good test of fairness is whether the term undermines the consumer's ordinary rights in law. For example:

- a clause in a contract for an 'off-premises' purchase that places any kind of limitation on the consumer's 14-day cancellation period. This would certainly conflict with the legal rights the consumer has.

Warning: A contract that is unfair in law (as above) cannot be made acceptable if it states that the consumer's 'statutory rights are unaffected'.

Exemptions from the test of fairness

A few terms are exempt from the fairness assessment. Those that simply specify:

- the main subject of the contract (the goods to be installed); and
- those that relate to the appropriateness of the price.

Provided those key terms are transparent (easily understood) and prominent, then it is the intention that the main subject of the contract, and its price, is regulated by the market.

These exemptions are very narrow however, and do not extend to other clauses that cover, for example, the timing, method or variation of payment.

6.5 Why unfair contract terms are damaging

While unfair contract terms are not legally binding, they can be misleading. For example, an unfair clause may convince a consumer that they have no legal rights to resolve a complaint when, in fact, they do. This is why unfair clauses can be so damaging and the harm remains unseen. Unfair clauses must not be used.

This is why the Competition and Markets Authority (CMA) and local Trading Standards Services can take enforcement action against companies using unfair contracts.

Unfair terms can be damaging in a range of other ways and these are explored in 7.0 Unacceptable terms in microgeneration contracts on page 64.

7.0 Unacceptable terms in microgeneration contracts

Summary – identifying and avoiding unfair terms

Examine your contract from the consumer's perspective. Would you be happy to sign it?

Your contract should:

- avoid ambiguous statements
- use ordinary words and be easy to read and
- be up-front about the key terms such as the various prices involved, the products to be installed and the terms of installation.

MCS Information on Performance.

The MCS performance disclaimer and any other MCS information on potential performance, cannot be used to curtail a consumer's legitimate complaint about an estimate that was not completed with reasonable skill and care. You must not contradict the MCS information with other claims you may provide.

Use Grey List terms with extreme care or not at all. The following are often problematic and likely to be unfair and therefore have no power in law:

- Terms that seek to limit your company's liability if things go wrong.
- Terms that allow you to vary the contract after it has been signed (without the consumer's consent).
- Terms that transfer risk to your customer that they are unable to control.
- Terms that enable you to keep deposits and/or advance payments if the installation does not proceed through no fault of the consumer.
- Terms that impose excessive penalties on your customers if there is a dispute or if they are in breach of contract.

See below for more detail.

Get your contract terms right. RECC has a 'model' consumer 'terms and conditions' contract available which you can use to ensure your terms are fair. Other Consumer Codes should have an equivalent model available.

7.1 Introduction

This chapter describes the MCS disclaimer and how it must not be used unfairly, including actual examples of microgeneration contracts to illustrate poor practice in contract terms. It also describes what you can do to improve the terms you use.

Tip: While your ‘terms and conditions’ document is used to clarify the terms of the agreement, you can be bound by the terms in other documents such as your quote, advertising material and even the information you give verbally. It is also important for your documents to be consistent.

7.2 The MCS Performance Disclaimer

Information related to potential performance provided by MCS (such as the MCS disclaimer) cannot be used to justify a performance estimate, or claim that is completed incorrectly or without reasonable skill or care. The Competition and Markets Authority makes it clear that disclaimers (and any other contractual information provided) can be unfair if they curtail a consumer’s legitimate right to seek redress from a trader who has not complied with its general obligations.

The MCS disclaimer described in MIS 3005 states that the estimate cannot be predicted with ‘certainty’ because of the variability of the climate. This clause, and any other information provided by MCS on performance forecasts, must not be used unfairly.

To avoid doing so the following points are important:

- the MCS information cannot be used to restrict liability for misrepresenting the performance calculation;
- the MCS Contractor may provide alternative performance estimates in addition to the MCS HPSPE providing they:
 1. Clearly indicate why there are any significant differences in the estimates if such differences exist;
 2. Fully communicate what aspects have been included/excluded from the estimate (e.g. local weather data rather than national; different external or internal temperatures; circulation pumps etc) which lead to differing figures;
 3. Make it very clear that this alternative is still only an estimate of performance and subject to other influencing factors;
 4. Emphasise that if the performance estimates are used as a basis for financial pay back decisions then the accuracy of the calculation should be reflected in the potential extremes of the financial outcome and the customer made aware that performance variations could significantly effect the final outcome.
- it would be consistent with the principle of fair and open dealing to draw a consumer’s attention to the disclaimer and any other information provided by MCS on factors affecting performance.

7.3 Transparency

Consumers must be able to understand your contract. The law specifically requires contractual terms to be written in plain and intelligible language. Your contract, therefore, should not include legal jargon.

Legal jargon includes words and expressions such as 'indemnity', 'force majeure', 'time is of the essence' and 'joint and several liability'. Such terms should be avoided or explained. If you use confusing or opaque language and there is a dispute about the meaning of a term, then the meaning that is most favourable to the consumer will apply.

Example: This clause is confusing, unclear and therefore unfair:

“Save as expressed in this Condition (and subject always to Condition xx), neither the company nor its subcontractors, servants or agents shall be liable, whether in contract, in tort (including but not limited to negligence) or by reason of breach of statutory duty or otherwise, in respect of defects in or damage to the works or any part thereof, or for any damage or loss of whatsoever kind attributable to such defects or damage or any work done or service or advice rendered in connection therewith.”

7.4 Terms that restrict or exclude liability

These terms try to deny or limit liability for:

- poor services; or
- for negligently causing delay or damage to property – this is often termed 'consequential loss'.

Contracts for microgeneration often attempt to exclude liability for consequential loss. The actual terms used can be termed 'disclaimers' or 'exclusion' clauses.

If you fail to honour your obligations under a contract then the consumer has a right in law to seek compensation. Equally, if the consumer is in breach of his or her obligations then you can seek compensation. The following terms would therefore be unfair:

- limiting liability to the value of the goods sold,
- requiring the consumer to meet costs that in law would be for the trader to pay (for example, by making call-out charges non-refundable and/or charging the consumer for the costs of returning faulty goods); or
- limiting the liability to the extent that the supplier can claim against the manufacturer.

Example: Both of these examples were removed from a microgeneration contract:

“The Seller shall not be liable for any consequential, indirect or economic loss or for any loss of profits, business, revenue, goodwill or anticipated savings whether arising from breach of contract, tort, breach of statutory duty, misrepresentations or otherwise i.e. wider than 'consequential loss'.”

“... the Seller's liability to the Buyer under any Contract howsoever arising shall be limited to the price of the Goods or Services specified.”

7.5 Terms that restrict or exclude liability for delay

By law you are required to supply goods and services on a date agreed with the consumer, or, if no date is fixed, within a reasonable time. Terms that enable installers to ignore deadlines and disregard verbal promises are unfair. On the other hand, terms that exclude liability for circumstances that are genuinely beyond the control of the installer are acceptable.

Terms are unfair if they:

- exclude liability for delay; or,
- allow the company long periods to deliver goods and/or complete the installation.

7.6 Terms that exclude the supplier's liability for claims or promises not written in the terms

You cannot exclude liability for any statements that are not in the written contract agreement document or the terms document. Clauses that attempt to do this are known as 'entire agreement clauses' and are a common source of dispute. Equally, clauses that state that all additions or variations to the contract must be made in writing can also be unfair because the installer may wrongly claim that a verbal promise made by an authorised member of staff is not relevant.

You can, however, warn consumers that they should read your terms carefully to make sure they understand it and they are satisfied with what it includes and excludes. You should also encourage consumers to ask questions about the contract to clarify points of confusion.

Example: An unfair clause that seeks to exclude liability for claims made:

“ This contract sets out the entire agreement between the parties relating to it's [sic] subject matter and unless otherwise agreed in writing by the parties (whose agreement must refer to this clause), shall override any prior correspondence or representations and all other terms and conditions. ”

7.7 Terms that seek to give the supplier an unfair right of final decision

If there is a dispute between you and a consumer, both parties have the right to seek redress. You cannot claim to have a final say in a disagreement or claim the power to decide on the meaning of the terms in the contract.

Example: The following is an unfair right of final decision (encompassed in the words 'at our sole discretion') in relation to a warranty:

“ We take pride in the quality of our Products and Services. If you establish to our reasonable satisfaction that there is a defect in the materials or workmanship or our Products or Services, then we shall at our sole discretion and within a reasonable time:

- (a) repair or make good such defect in such Products free of charge to you;
- (b) replace such Products or re-perform such Services; or,
- (c) issue a credit note to you for the whole or part of the price of such Products or Services as appropriate. ”

7.8 Terms that seek to allow the supplier to vary the price or the goods supplied

You cannot include terms that give you the power to vary what you have stated will be supplied and how it will be installed without consent. Consumers have rights in law to the goods and services at the price agreed.

You can include terms that allow for changes provided:

- the changes are limited and defined in scope
- there are genuine reasons why they are necessary, and
- the consumer fully understands the reasons for the changes and agrees to them in advance.

You may include terms that allow for minor changes that will be of no real significance to the consumer. These changes may be necessary for safety reasons, for example.

Equally, you cannot vary the price agreed without giving your customer the chance to cancel the contract.

Example: The following terms are unfair:

“Changes: From time to time, we may change our Product or Services offerings, prices and/or these terms and in such event, we will give you reasonable notice of changes.”

“The company reserves the right to change technical specification, parts and installation procedures if in the opinion of the technical staff such changes are needed to facilitate product performance.”

7.9 Sanctions

As described above, consumers are not bound by unfair terms. Even so, the CMA and local Trading Standards Services can take enforcement action against companies using unfair contracts.

Additionally, individual consumers can take legal action independently of any sanction imposed by the CMA or other regulator. Where a trader refuses to accept a term is unfair or blacklisted, the consumer can resist legal proceedings brought by the trader or can instigate proceedings themselves.

7.10 What can installers do to improve contract terms?

- The CTSI Approved Consumer Codes have ‘model’ consumer ‘terms and conditions’ contracts available. These can be used ‘off-the-shelf’ or adapted - provided any changes you make are fair and transparent.
 - Contact your Consumer Code for advice about specific terms included in other documents.
 - If you don’t use a ‘model’ contract or you are not sure about the status of the contract you are using - get it checked or ask your Consumer Code for advice. Your local Trading Standards office may be able to check your terms: <https://www.tradingstandards.uk/consumers/support-advice>
 - For more general guidance see the Competition and Markets Authority online help: Writing fair contracts: guidance for businesses: <https://www.gov.uk/government/collections/writing-fair-contracts-guidance-for-businesses#guidance>
 - For more information on the Grey List see Schedule 2 of the Consumer Rights Act (<http://www.legislation.gov.uk/ukpga/2015/15/schedule/2>) or the full guidance on unfair contracts published by the Competition and Markets Authority for detailed information about all categories of Grey List terms. (<https://www.gov.uk/government/publications/unfair-contract-terms-cma37>)
 - Make sure that contractual terms in all the other documents you supply are:
 - consistent with your terms and conditions and
 - consistent with the above legislation
 - If you do not use a ‘model’ contract then you must use terms that comply.
-

8.0 Goods and services, including installation – your obligations in law

Summary – your legal obligations relating to goods and services

Knowing your wider obligations in law will help you avoid confusion and disputes through better and clearer agreements.

This chapter provides the basics; use the links for more information.

Be aware of your obligations when supplying goods and services.

Consumer protection law includes obligations related to goods and a related set of obligations for services. It is important to be aware of the rights and obligations that apply to both¹.

¹ See Consumer Right Act Explanatory Notes, paragraph 32 <http://www.legislation.gov.uk/ukpga/2015/15/notes/division/3/1>

8.1 Introduction

Microgeneration installers supply goods and complex services. It is therefore critical to understand your obligations in law related to the very specific rights consumers have. For example, not only must goods be fit for purpose, you must describe them correctly. Furthermore, services must be carried out with reasonable skill and care and provided in line with the verbal and written information you have given.

8.2 Goods

Consumers have three core statutory rights under the Consumer Rights Act, these are:

The goods must be of satisfactory quality

This is assessed using many factors such as the item's price, the description you gave it and the advertising. In microgeneration, other factors would also be important such as whether it functions as described, is durable and is safe.

The goods must be fit for purpose

By providing a contract proposal, you are recommending a specific solution for the purpose described. The goods must work for that particular purpose.

The goods must be as described by the trader

If a consumer relies on information you have supplied (in a quote or in advertising for example), then that description must be correct. It can be an offence to provide misleading or incorrect information (see 5.4.1 The Consumer Rights Act 2015 (CRA) on page 58).

The above rights are fixed in law and businesses cannot seek to undermine them in any way using any other contractual term (see 6.0 Unfair Contracts on page 60).

It is important to note two other provisions in the Act:

You must make sure the goods supplied are installed correctly (see scenario on page 72)

If goods are installed incorrectly then the consumer will have rights and remedies under the 'goods' section of the Act. This applies even if the goods are not faulty and underlines the importance of having a clear agreement about the installation design.

You must have a right to sell

The trader must have the legal right to transfer ownership of the goods to the consumer when the consumer takes possession of them.

8.2.1 Guarantees are legally binding

Under the law, businesses do not have to provide guarantees but RECC members must offer a guarantee against manufacturing faults and a minimum two-year workmanship warranty. Where guarantees are offered – they are legally binding and the guarantor must ensure that the guarantee:

- is written in plain, intelligible language;
- makes it clear that the consumer has statutory rights under the Act in relation to the goods and that those rights are not affected by the guarantee;
- includes the name and address of the guarantor;
- includes the duration and territorial scope of the guarantee; and,
- is made available within a reasonable time and in writing.

Scenario: The Retailer's Responsibility

Mr Smith's air source heat pump system has stopped working four years after installation and outside the 'parts' guarantee period. Because the fault is due to a part that is simple and easy to replace, the trader is unlikely to be in breach of the right to goods of satisfactory quality. However, if the Heat Pump system broke down entirely four years after installation (and outside the system's guarantee period) and could not be repaired, then the customer may have rights under the Act. Most reasonable people would assume a heat pump installation should last much longer than four years.

8.3 Services

Consumers have two core rights in law related to services. The service must be:

- carried out with reasonable skill and care; and
- provided in line with information given about the service or the trader.

8.3.1 Reasonable skill and care

The concept of 'reasonable skill and care' relates to how the service is delivered rather than just the end result. This means that your company can still be in breach of the right even if the installation is successful.

Overall, if a court has to decide whether a company used reasonable skill and care when performing a service it will judge the service provided against the normal Standards of the industry. For example, the company's service would be measured against MCS Standards and the applicable Consumer Codes.

8.3.2 In line with information given about the service or the trader

You should note that all verbal or written statements made by the company are binding if that information influences the consumer's decision when deciding to enter into the contract. See 5.4 What the law says about information you choose to provide on page 58.

8.3.3 Service to be provided at a reasonable price and within a reasonable time

There are two additional rights. The service should be provided:

At a reasonable price

4.2 Information you must provide in law on page 48, explains that you are bound by the law to make the price for the installation clear in the contract agreement before it is signed. However, this legal requirement provides an additional safeguard to consumers if any potential costs are not made clear.

At a reasonable time

The timetable for the installation is a frequent source of dispute between installers and consumers. Consumers may need the installation to be completed by a specific date so they can access incentive scheme support. For this reason, RECC members are required to include a timetable for the installation in the contract. The law requires the service to be carried out 'within a reasonable time'.

8.4 For more information

For more detailed information see the RECC scenario-based guidance to the Consumer Rights Act available from the members' section of the RECC website.

See also the Business Companion website for more detailed information on the supply of goods and services².

² <https://www.businesscompanion.info/>

9.0 Dealing with complaints and disputes

Summary - Your process and independent arbitration

Even the best and most diligent companies receive complaints. But most complaints can be resolved with the minimum of fuss provided the installer responds quickly, sympathetically and with good communication.

If you don't deal with a complaint quickly and effectively it may turn in to a costly and time-consuming dispute. All of the information in this guidance will help you avoid complaints by making sure your consumers can make an informed choice. Things can go wrong however, and it is important you have an effective complaints process and, if the matter is not resolved, consumers have clear access to dispute resolution through your Consumer Code and/or MCS.

9.1 Your Complaints Process¹

RECC sets out a number of minimum requirements for your complaints process. For example, your company will:

- respond to any written complaint within 10 working days;
- arrange to inspect the installation (if appropriate) within seven days of becoming aware of the complaint and within 24 hours where the consumer is without heating or hot water as a result of the problem that led to the complaint;
- agree a course of action to resolve the problem speedily and effectively to the consumer's satisfaction.

¹ Check your own Consumer Code for specific rules on dispute resolution.

9.2 Disputes

Where complaints cannot be resolved using the above process then:

- if the complaint is partly or wholly about technical aspects of the MCS installation then the consumer should direct their complaint to the MCS Company (if the consumer gives their permission, RECC may also pass on complaints about technical aspects of an installation to the relevant MCS Installer Certification Body); and
- if the dispute relates to issues covered by RECC (or other Consumer Code) then the consumer should direct their complaint using the RECC online dispute registration form (or equivalent process for other Codes).

Following notification of a dispute, RECC will mediate between the parties to find a resolution that is fair and acceptable to both the consumer and installer. Consumers may give their permission for a friend or relative to help deal with a dispute. In this case, Code members must co-operate fully with this person.

9.3 Independent Arbitration or Ombudsman Service

Some disputes cannot be resolved amicably even when there is mediation. In these cases the consumer has the right to refer the dispute to Independent Arbitration under RECC and the installer must cooperate with that process. Alternatively, consumers also have the right to take legal action.

An award made under the Independent Arbitration Service shall be final and binding on both the consumer and the Code member, and enforceable.

**Appendix 1 – Information to be made available:
'off-premises' contracts**

'Off-premises' Contracts

The law recognises that some consumers can be vulnerable to mis-selling in the home and the legal obligations placed on home sellers attempts to mitigate those potential problems. Installers who sell 'off-premises' therefore must provide significantly more information (prior to contract agreement) than for 'on-premises' sales. The full list is laid out Schedule 2 of the CCRs 2013¹ and is in addition to the information related to consumer's right to cancel as explained in 3.0 The Right to Cancel on page 42.

Any failure to provide the full list of information (where applicable) as set out in Schedule 2 would allow the consumer to claim a breach of contract. Equally, and as described in 5.4.1 The Consumer Rights Act 2015 (CRA) on page 58, if any of the information is wrong, then your customer could claim a breach of contract under the Consumer Rights Act 2015².

**Appendix 2 - Information to be made available:
'on-premises' contracts**

'On-premises' contracts

Installers who sell 'on-premises' must provide the information as laid out in Schedule 1 of the CCRs³. The legislation states that the information must be made available "before the consumer is bound by" the contract⁴. This means that any failure to provide the information may be a breach of contract.

The law does not specify how the information should be published, but it is accepted that it can be provided from a variety of sources such as the quote, the contract terms and price lists⁵.

¹ <http://www.legislation.gov.uk/uksi/2013/3134/schedule/2/made>

² <https://www.businesscompanion.info/en/quick-guides/consumer-contracts/consumer-contracts-off-premises-sales>

³ <http://www.legislation.gov.uk/uksi/2013/3134/schedule/1/made>

⁴ <http://www.legislation.gov.uk/uksi/2013/3134/made/regulation/10> and Schedule 1

⁵ <https://www.businesscompanion.info/en/quick-guides/consumer-contracts/consumer-contracts-on-premises-sales>

Appendix 3

MIS 3005 – Information to be provided by the MCS Contractor to the Consumer.

Information that must be provided in all circumstances (see specific MIS 3005 paragraphs for more detail).

The MCS Contractor shall:

4.2.3 – estimate the DHW re-heat times and then discuss and agree those times with the consumer.

4.2.9 – explain the implications of the space heating and DHW system design on the costs associated with providing space heating and DHW to the building.

4.2.16 – provide the MCS Heat Pump System Performance Estimate before the contract is agreed.

4.2.16 – explain how the flow temperature affects the efficiency performance and explain the cost and benefits of achieving a higher SCOP/SPER.

4.2.17 – once (or before) the contract is agreed, provide the consumer with the full design information such as specific room heat losses and emitters specified.

4.2.25 – provide the consumer with the design detail as laid out in Table 3 of MIS 3005 (GSHP only).

4.3.1 – provide the domestic EPC.

4.3.3 – provide the compulsory performance estimate with the MCS disclaimer as detailed in 4.3.3.

4.4.2 – make consumer aware of all permissions, approvals and licenses such as those required for the abstraction and discharge of ground water (where possible, MCS Contractors shall ensure such permissions are obtained before work starts).

6.1 – 6.3 – provide the necessary information as required at handover.

Information that must be provided in specific circumstances (see specific MIS 3005 paragraphs for more detail).

The MCS Contractor shall:

4.2.2 – (where other heat sources are available to the same building) explain the proportion of the building's space heating and DHW to be provided by the heat pump.

4.2.11 – (where the system is intended to be eligible for the domestic RHI or where metering/monitoring equipment is to be fitted to an existing installation) explain the metering required and give details in the quote.

4.2.18 – (where the full survey design results in a revised design and/or estimate of performance) issues an updated MCS Heat Pump System Performance Estimate and variation to contract.

4.3.4 – (where an 'additional performance estimate' is provided using an alternative methodology and/or alternative seasonal performance) justify the methodology and provide an associated warning that the estimate be treated with caution.

Appendix 4 – The CAP Codes

The core principles of the CAP Code are that all marketing must be legal, decent, honest and truthful and must reflect the spirit, not merely the letter, of the Code. The sections of the Code that are most relevant to MCS Contractors are described below:

Section 1 Compliance: This describes the principles that underpin the Code and how marketing must be prepared with a sense of responsibility to consumers and to society. It also details how advertisers are responsible for responding to enquiries from the ASA and CAP.

Section 2 Recognition of marketing communications: This section states that consumers must be able to identify marketing material as promotional. In other words, the commercial intent of the material should not be camouflaged in any way – for example, advertising material masquerading as independent or editorial.

Section 3 Misleading Advertising. This part of the Code is probably most relevant to MCS installers as it defines what is and is not ‘misleading’. Under these rules marketers must not mislead by the omission of ‘material information’. Where prices are included in advertising then the ‘material information’ includes the main characteristics of the product, the price, delivery charges, arrangements for payment and the consumer’s right to cancel. Section 3 also states that advertisers must:

- be able to substantiate their claims by holding documentary evidence (that consumers are likely to regard as objective)
- not exaggerate the capability or performance of a product
- not use price statements that can mislead by omission, undue emphasis or distortion and must include non-optional taxes
- include the cost of applicable delivery, freight or postal charges
- follow strict rules when comparing products and prices
- not mislead consumers about who manufactures the product and must not attempt to discredit or denigrate another product, marketer, trade mark or trade name
- hold documentary evidence for any testimonials or endorsements unless it is obviously fictitious, and
- follow strict rules about the use of the word ‘guarantee’ in marketing.

When the ASA considers whether an advert is in breach of this part of the Code, it will refer to the Consumer Protection from Unfair Trading Regulations 2008 (the CPRs).

Section 11 Environmental Claims. Advertisers must:

- be clear about the basis of the environmental claims you make (unqualified claims can mislead if they omit significant information)
- make the meaning of all environmental terms clear to consumers (see the Department for Environment, Food and Rural Affairs (DEFRA) guidance below for more information)
- support absolute claims with a high level of substantiation
- base environmental claims on the full life cycle of the product, unless the marketing material states otherwise, and you must make clear the limits of the life cycle; and
- avoid the suggestion that claims are universally accepted if there is a significant division of informed scientific opinion.

The CAP Code says marketers should refer to Government guidance on environmental claims. DEFRA provides advice on clear, accurate, relevant and substantial environmental claims on products, services or in marketing and advertising⁶.

If you are unsure whether your proposed non-broadcast advertisement or marketing campaign will comply with the CAP Code, you should use the CAP Code Copy Advice Service⁷.

The BCAP Code

While the CAP Code is of most relevance to providers of microgeneration, some MCS installers have used broadcast advertising. If you choose to use television or radio commercials in your marketing then you must follow the BCAP Code – this means that your ads must be pre-cleared before they are transmitted.

Television ads must be pre-cleared by a body called Clearcast⁸.

Radio ads must be pre-cleared either by Radiocentre⁹ if they are in the ‘special categories’ list of subject areas. Exempt ads can be pre-cleared by the radio station whose service will broadcast the ad. See Section 1: Compliance of the BCAP code for guidance¹⁰.

⁶ <https://www.gov.uk/government/publications/make-a-green-claim>

⁷ <https://www.asa.org.uk/advice-and-resources/bespoke-copy-advice.html>

⁸ <https://www.clearcast.co.uk/>

⁹ <http://www.radiocentre.org/advertising/>

¹⁰ <https://www.asa.org.uk/codes-and-rulings/advertising-codes/broadcast-code.html>

MGD
002
issue 2.0

A Guide to MIS 3005 V5.0



Introduction

This part of the guide addresses clauses within MIS 3005 V5.0. It is broken down into sub-sections to replicate those of the MIS Standard for ease of reference only. It does NOT address every single clause but only those where it is felt further explanation and guidelines are required. If there are queries on the clauses listed or on clauses not specifically listed below, the enquirer should contact MCS.

1) MIS 3005 Section 1

- a) Clause 1.3 - This refers specifically to the individual heat pump output <45 kW thermal.
- b) Clause 1.4 - This emphasises that multiple heat pumps may be employed subject to Clause 1.5.
- c) Clause 1.5 - This refers to the combination of individual heat pumps conforming with clause 1.3 to make up a system. Further guidance is available on the MCS website.
- d) Clause 1.7 - Certain activities are covered by statutory requirements, for instance, to hold specific certifications such as the handling of F Gas Refrigerants and installing plant requiring a natural gas connection (Gas Safe). Any statutory requirement including Building Regulations shall take precedence over requirements within MIS 3005, should there be a conflict.
- e) Clause 1.10 - MCS does not permit the extraction of heat from any space which would in turn cause a load on the space being heated. For example, if the loft temperature were above the highest design temperature for the rooms below then heat could be extracted down to that temperature but not below (i.e. not imposing a heat loss on the spaces being heated). Therefore, heat may be extracted from an adjoining plant room but again only to a temperature equal to or above the highest design temperature of adjoining rooms.
- f) Clause 1.11 - This refers to heat pumps designed to only generate domestic hot water and not for space heating. These devices would normally have a storage vessel built-in or the prescribed storage vessel is supplied disconnected but part of a specific package and the two elements are required to be connected together on site.

2) MIS 3005 Section 2

- a) Definitions - Further definitions can be found in this document and in MCS 007 Product Standard.

3) MIS 3005 Section 3

- a) Sub-section 3.2- Quality Management System (QMS): MCS now provides outline QMS documentation in the form of templates.
- b) Sub-section 3.3 - Subcontracting: This section should be read in conjunction with MCS 001.

4) MIS 3005 Section 4: Design & Installation Requirements

- a) Clause 4.2.1.a) - “A heat loss calculation should be performed on the building ...shall in other respects comply with BS EN 12831.”

Covers intermittent and continuous heating systems.

Intermittent systems should be designed to provide sufficient heat for an outdoor ambient covering 99% of the year with a margin for start-up from cold. This margin may be determined from the CIBSE Domestic Heating Design Guide 2017 based on EN 12831. Alternatively, a margin of 20% should be added.

Continuous systems have to be designed to provide sufficient heat to cover 99.6% of the year and therefore it is felt a margin is not required. However, good practice suggests a small margin should be provided for start-up from cold (approximately 5-10%) however this is likely to be provided by selecting the next nearest available heat pump.

In practice all systems could be regarded as continuous heating since at very low ambient temperatures the systems are likely to be run continuously to maintain conditions. Therefore, if systems are designed to be run continuously but controlled in a semi-intermittent way with ‘set back’ function this may optimise system capacity and operational efficiency.

In turn it could be considered that all systems are 'intermittent' to the extent that they may be turned off during periods of absence (e.g. holidays) and therefore some start-up spare capacity should be provided, at the very least, to the heat emitters. Complete disabling of such systems is not recommended and a temperature set back regime (whether automated or manual) should be employed to protect the building fabric and services (e.g. from frozen pipes leaking on thawing).

In terms of the actual calculations care should be taken when using design packages supplied, especially when they are at no cost. Methods that comply or which are in line with EN 12831, are the CIBSE Domestic Heating Design Guide, Bentley Hevacomp, TAS, IES, and the MCS heat loss calculator (which is freely available). SAP should not be used to calculate a peak heat loss as it uses mean values for the whole house rather than accurate room-by-room calculations. Only compliant tools will enable accurate sizing.

b) Clause 4.2.1.c) - Requires MCS Contractors who are proposing 'high temperature' heat pumps (HTHP) ($>55^{\circ}\text{C}$ flow) to provide an alternative design with 'standard' operating temperature heat pump. They will also need to provide a Heat Pump System Performance Estimate as Clause 4.2.9 bullet 1 and clause 4.2.16 for both the HTHP system and the 'standard' heat pump system. In this case the 'standard' heat pump SCOP shall be obtained from the MCS website using a similar model from the same manufacturer and range or as close to an alternative as possible.

c) Clause 4.2.1.d) - Table 1 is based on CIBSE Guide A which gives internal design temperatures for a variety of spaces both domestic and non-domestic. Generally, the heating system shall be designed to achieve these temperatures as a minimum, based on the external ambient determined in clause 4.2.1.a). In exceptional circumstances where there is a clear custom and practice to heat the rooms to a lower temperature (for example, in poorly insulated, listed buildings/dwellings and particularly those with unusually large domestic space) rooms may be heated to lower temperatures to prevent condensation ($\geq 16^{\circ}\text{C}$). 'Unusually large spaces' would typically be in excess of 50m^2 with ceilings exceeding three metres, however this is not a rule but a guide.

In addition, ancillary rooms such as utility rooms and cloak/boot rooms may fall into this category however they would need to be regarded as not normally occupied (i.e. transient) and able to be isolated from other fully heated spaces with well-fitting doors. Typically, such rooms, which are less than 2.5m^2 , might be considered to require only background heat, circa 16°C .

External door lobbies (i.e. rooms with a door to outside and a door barrier inside leading to the entrance hall) which are clearly intended only for the purpose of exiting and entering the building, including the application and removal of outer garments and footwear, would not need heating, provided they are less than 2.5m^2 or they are outside of the main wall structure (e.g. cavity wall or thick solid wall, 225mm or greater), or have a thermally inferior wall construction (e.g. thin, single skin) and have a door to any adjoining space.

d) Clause 4.2.1. e) - This applies to the situation where the heat pump is the only source of heat other than supplementary heaters designed to operate in accordance with clause 4.2.1.b).

This is generally covered by the bi-valence criteria. If a dwelling has insufficient electrical power for a heat pump to achieve 100%, it can use another heat source.

e) Clause 4.2.1. f) - This is generally covered by the bi-valence criteria. If a dwelling has insufficient electrical power for a heat pump to achieve 100%, it can use another heat source provided that they have an integrated heating system. If the proposed solution is, for example, a domestic biomass system, then this is unlikely to be possible.

f) Clause 4.2.1. g) - Where a dwelling uses a different heat source for different zones (e.g. direct acting heaters in bedrooms upstairs and low temperature wet system downstairs), controls are required for each zone which prioritise the lower carbon heat source and reflect the effects of heating a common space, for example, a landing.

If a zone is heated by a combined system, then it needs to have an integrated system control.

A bi-valent or multivalent heating system must be on a single integrated control circuit and cannot have any mono-energetic space heating above the geographical design external ambient temperature. An immersion heater can be used for hot water heating as long as the local Building Regulations and Standards are taken into account. Local Regulations normally require the lowest carbon heat source to provide the load and the supplementary heat to the source to be used as a back-up.

The householder can also have a wood stove or other manual heating system separate from the main heating system but any auxiliary heat sources can only be included in the mono-to-multivalent heating design load temperatures if they are automatically controlled by the integrated heating control circuit. All automatically controlled heat sources must be fully interlocked.

Definitions to assist installers:

Monovalent = A heat pump heats the building alone, without any other form of primary energy input (e.g. direct electric immersion).

Bi-valent = A heat pump operates with support from an additional heater. Two methods are described below:

- *Bi-valent Mono-energetic = This is a concurrent bivalent system where secondary supplementary heater is also electric. Therefore, there is only one energetic source: electricity.*
- *Bi-valent Bi-energetic = This is a bivalent system where the secondary heater is a source other than electric. Therefore, there is more than one energetic source. These systems may be controlled with both sources concurrently or as a changeover mode.*

In terms of control of Bi-valent systems, again, there are two main options:

- *Bi-valent concurrent: A heat pump continues to operate alongside the secondary (supplementary) heater.*
- *Bi-valent changeover: A heat pump stops and an alternative heater takes the full heating load.*

Please note:

Bi-valent point = Outside temperature below which the back-up may be required. This setting is a parameter configured into the controller.

- g) Clause 4.2.6 - Certified Solar Assisted Heat Pumps (“Thermodynamic”) are currently specifically only certified for hot water production and not space heating.
- h) Clause 4.2.7 - Please note that the references to guidance on legionella prevention refer to non-domestic guides and therefore need to be adapted for domestic situations. The HPSPE provides only for daily or weekly pasteurisation however this should not be assumed to be guidance for the prevention of legionella growth and propagation in all circumstances. If in doubt a specialist should be consulted.
- i) Clause 4.2.16 - Heat Pump System Performance Estimate (HPSPE) - For guidance on the HPSPE refer to the Appendix rear of this guidance document - “Appendix 1 - HPSPE Guidance”
- j) Clause 4.2.17 - “Reasonable time” - this has not been defined and will be affected by the particular circumstances of the project, availability of the client for discussion, complexity of the project and current industry demand levels etc. However, a typical period of within four weeks is a starting guideline. It is recommended that an outline programme for the development of the works is agreed with the consumer at the earliest opportunity. In addition, some Consumer Codes require an indication of timescales to be given to the consumer at point of purchase order.

Refer to Part 2 - Getting the contract right on page 33.

- k) Clause 4.2.18 - This is covered in more detail in Part 2- Getting the Contract Right and, in particular, but not limited to, 2.2 – The Energy Performance Certificate (EPC) on page 36.
- l) Clause 4.2.19 - This highlights the risks in designing ground arrays especially for high duty domestic installations.
- m) Clause 4.2.20 - Such software would be complete software and not partial or trial copies.

This clause refers to the use of software which is ‘validated for UK use’. In the absence of a detailed specification against which software can be measured, MCS Certification Bodies will verify whether software used by MCS installation companies meets the requirements detailed in MIS 3005 (i.e. Clause 4.2.12 which includes the list of parameters which should be inputted into the software).

MCS is working to detail the specifications that software must meet and will make this available in this guidance document at a later date, with an accepted tolerance level for any deviation from expected results.

Warning:

It is unlikely that software which is publicly available and free will comply with this clause. In the case of manufacturers software, it is expected that the Contractor has received specific training from the manufacturer and is in some way registered or recognised by the manufacturer as competent to use the software. The manufacturer must warrant the use of this software or take in-house design responsibility.

n) Clause 4.2.21 - MCS 022 Ground Loop Look-up Tables

Warning:

These look-up tables refer to specific pipe diameters and spacings etc. and may only be used in compliance with these parameters. When deviating from these parameters the Contractor must demonstrate competence to assess such deviation which will likely involve using software conforming to clause 4.2.20 and/or employ a recognised specialist to undertake the design and assessment.

o) Clause 4.2.22 - As with Clause 4.2.20 above, in the absence of a specification and accepted tolerance level for design methods to be verified against within this guidance, the MCS Certification Body will verify whether that design method and installation practice meets the requirements of MIS 3005.

p) Clause 4.2.23 d) - This estimate of ground conductivity shall have substantiating evidence, such as experience in the location, via an independent recognised specialist, or cautious use of BGS data. In all other cases the lowest ground conductivity factor listed in the look-up tables (MCS022) should be used.

Warning:

Assessment of ground conductivity is vitally important and has a major impact on the effectiveness and efficiency of the GSHP system.

q) Clause 4.3.1 - Re EPCs: see Appendix 1 - Heat Pump System Performance Estimate (HPSPE): Specific Guidance Note on page 87.

Warning:

It is the Contractor's responsibility to give, where requested, an accurate prediction of running cost. In situations where the sale of a heat pump system is based on savings accrued from running such a system as compared with an alternative (whether in existence - i.e. retrofit replacement - or for illustration purposes - i.e. New build) the Contractor is obligated under consumer legislation to provide accurate assessments.

Please note:

The MCS HPSPE is not intended to be accurate for comparison of alternative fuel systems but is intended to be used as a comparison for the relative performance of alternative heat pumps. The Contractor cannot rely on the HPSPE to provide actual running cost information or true comparisons with alternative fuels.

- r) Clause 4.3.2 - Separate energy performance calculations for space heating and domestic hot water heating must be produced, as the efficiency at which these are performed is likely to vary.

For space heating, the SCoP relating to the maximum space heating flow temperature must be taken from the product listing on the MCS website and used as directed for calculation purposes.

For production of domestic hot water, it must be clearly stated at what temperature water will be stored within the cylinder in normal operation and the heat pump flow temperature which is required to achieve this (e.g. 50°C flow temperature required to achieve 45°C stored water temperature). The annual energy consumption to achieve this on a daily basis should then be calculated based on the appropriate heat pump water flow temperature from the HPSPE document.

Additionally, the frequency at which legionella pasteurisation will be performed should be clearly stated (e.g. daily/weekly), to what temperature the stored hot water temperature will be raised and the means by which this will be achieved.

5) MIS 3005 Section 5

This section endeavours to impress upon the MCS Contractor that they are fully responsible for all works identified within the Standard as being in the scope of MCS whether they perform them or sub-contract them. This is of particular importance when operating a remote certification or 'umbrella' scheme or similar schemes involving zero or nominal value contracts between third parties who are funding the installation (e.g. Assignment of Rights under the RHI scheme or similar).

6) MIS 3005 Section 6: Handover

The importance of this section is often overlooked by MCS Contractors which can lead to non-conformances and other substantial issues. It is intended that the user/occupier/owner is left in possession of vital information relating to the basis of the design and also clear operating instructions. The Compliance Certificate must be filled out fully and correctly and uploaded to the MID. Failure to do so could invalidate the MCS Certificate and leave the Contractor exposed to claims for any associated losses.

7) MIS 3005 Section 7: Regional Offices

No explanation required.

**8) MIS 3005 Section 8:
Publications for Reference
and Further Reading**

Whilst the MCS Contractor is not required to adhere rigidly to these references and reading materials, it would be reasonable for a Certification Body to question a significant deviation from any specific guidance within them.

**9) Appendix A:
Roles and Competencies Requirements**

This is given for guidance.
See also MCS 025 for guidance.

**10) Appendix C:
Ground Conductivity Information**

As has been pointed out earlier in this document this information is given for general guidance only and to indicate the variation likely in ground conductivity within a soil type or over a range of moisture contents. The Contractor should not assume any particular soil has either the most optimistic value or even the average value without additional supporting evidence (see comments to Clause 4.2.23. d) on page 84).

Appendix 1 – Heat Pump System Performance Estimate (HPSPE): Specific Guidance Note

This Appendix refers to Section 4, item i) of MGD 002 Issue 2 which in turn refers to Clause 4.2.16 of the MIS 3005 Standard

1. Introduction

This guidance document has been produced specifically to assist with the production of a Heat Pump System Performance Estimate (HPSPE) previously known as Performance Estimate Template (PET).

MCS rules have been designed to allow contracts for the whole works to be signed prior to a full design. Due to concerns for consumer protection the HPSPE (PET) has been introduced to reduce those perceived risks. Without the HPSPE the previous requirement for full design at quotation stage would have been enforced.

MCS Contractors are expected to explain to potential customers receiving MCS compliant quotations that any financial information derived from the energy calculations are for comparison purposes and not accurate predictions of likely energy to be consumed or fuel costs.

2. Space Heating and Domestic Hot Water Energy Requirements - from EPC

The energy loads should be entered into the relevant box using the values found from a relevant EPC, draft EPC, 'F' SAP or RdSAP calculation. In the case where the building is also being altered (e.g. extended; additional insulation measures etc.) the figures may be taken from a draft EPC which may not be formally submitted until the works are complete. If the completed building differs from the draft EPC then a new, up to date HPSPE shall be provided to the customer as soon as these variations are apparent (as required by the Standard).

In the case of a property which cannot obtain an EPC the value shall be calculated from the design load and adjusted by degree day calculation or using full load equivalent hours figure.

3. Fuel Tariffs

Fuel prices are quoted in the usual form (see below) and it is vital to ensure the tariff used is of the same units as the HPSPE.

Fuel prices should be taken from actual bills for the property (if existing). If the fuel is typically price volatile e.g. oil or LPG, then an average over say 2-4 years would be preferable. The client may stipulate the figure to be used by all MCS Contractors quoting. If the building is a 'new build', prices contained in SAP may be used. The MCS Contractor may use alternative fuel prices however these should be explained and be from equivalent sources. For example, if the Contractor uses figures from an organisation charging for the service, all fuel prices used should be from this same source (e.g. Sutherlands, Nottingham Energy, etc.) or from other recognised bodies (e.g. Office for National Statistics). Only in rare circumstances would fuel prices come from different sources and in all foregoing cases the Contractor must explain the rationale if requested by the consumer, the Certification Body, the MCS Company, the CTSi Consumer Code scheme or anyone with a legitimate reason to request this information.

Electricity Economy 7 or 10 - This rate is most likely to relate to the fuel displaced. In this case, the tariff can be adjusted by the MCS Contractor to reflect an estimate of the ratio of electricity used for space heating and domestic hot water (as appropriate) between standard and economy tariffs. The resulting annual fuel cost can be checked against actual bills, bearing in mind that not all the fuel bill will be attributed to the heating and/or domestic hot water but will include lighting, refrigeration, small power etc. The split should be adjusted slightly if the result is unreasonable. As a guide, 'base' power consumption is typically ranging from approximately 5kWh/day for a single room apartment to approximately 13kWh/day in a 'standard' four-bed detached property.

If Economy 7 is to be used for the heat pump this must be discussed with the consumer in relation to their occupancy patterns, and the off peak allowance would normally be considerably lower than the on-peak consumption. The Contractor would have to explain any figure used to the CB or other scheme representative. A figure of below 10% would be preferred.

Scenario:

An MCS Contractor has been talking to a potential customer for some time regarding the installation of a heat pump system to replace their Economy 7 electric storage heating system in a three-bed, semi-detached property. The potential consumer has received several estimates indicating typical installation, running cost and payback calculations, and has now requested a 'quote'. In order to provide an MCS compliant quote, the MCS Contractor has advised the consumer of the need for an EPC and has requested and received an up to date copy of one. To ensure the quote is compliant, the MCS Contractor is going to include an HPSPE with the existing ('Alternative') fuel comparison of Economy 7 but is wondering what fuel unit cost to put in. During discussions, the MCS Contractor finds out that there are no obvious 'abnormal' uses for general electricity consumption.

'Abnormal' domestic uses would be outside those for typical domestic use such as for some additional function or process e.g. heating water for a window cleaning business; washing sportswear for a local team/school etc.

Further discussion reveals occasional use of the immersion heater to top hot water temperatures up using standard priced electricity. The Contractor makes the assessment that approximately 20% of electricity consumption for space heating and hot water will be at a standard tariff and 80% at Economy 7. The tariffs in this case are determined to be 7p/kWh and 15p/kWh unit respectively and the Contractor then uses the corresponding value:

$$((15p \times 20\%) + (7p \times 80\%)) = ((15p \times 0.20) + (7p \times 0.80)) = 8.6 p/kWh_e$$

The resulting calculation indicates a typical current running cost of the space heating and hot water system at £1,200. The client's annual bills are £1,700pa. This means £500 of their annual bill relates to activities other than heating and hot water and equates to an average base usage of approximately 9kWh/day, which is deemed to be within the typical range anticipated for this mid-range house. Therefore, the MCS Contractor issues this HPSPE based on the assumptions made and communicates these assumptions to the consumer.

Please note:

It is very unlikely that an Economy 7 tariff would be suitable for a heat pump system, so the MCS Contractor is advised that some assistance in evaluating the optimum tariff should be given to the consumer who may be unaware of the options and nuances of fuel tariffs. (See Part 1, 11.11 Future Heat Pump Tariffs or Smart Controls? on page 38).

Fuel Tariff Metrics - The tariff for each fuel should be based on the information in Table 4.

Table 4 - Fuel Tariffs by fuel type (all tariffs used should include VAT)

Fuel	Unit	Comments
Gas	p/kWh	Should include a standing charge, for example, Tariff Comparison Rate (TCR) if no other appliances will be used (e.g. hob, gas fire etc.) - i.e. a gas supply is no longer required. If gas is to be used by other appliances the tariff should exclude the Standing Fixed Charge.
Electricity	p/kWh	Electricity tariffs should not include a standing charge element unless it is intended that the heat pump(s) is going to be the ONLY electricity consuming device in the building.
Oil	p/litre	Assumes fuel conversion rate (FCR) of 10.35 kWh/litre ('28 second' heating oil - i.e.kerosene).
LPG	p/litre	Assumes a FCR of 7.1 kWh/litre
Coal	p/kg	Assumes a FCR of 8.21 kWh/kg
Wood Pellets	p/kg	Assumes a FCR of 4.7 kWh/kg (at moisture content <20%)
Seasoned Wood	p/kg	Assumes a FCR of 4.3 kWh/kg (at moisture content < 30%)

Please note:

It is vital that the MCS Contractor makes it clear that any indicated fuel costs are for comparison ONLY, and to demonstrate the effect of different design flow temperature settings. Due to the number of factors involved these figures are unlikely to be exact.

4. Energy Performance Certificates (EPCs)

Existing Properties

It is preferred that the EPC should be provided by the client/householder. The same EPC shall be used by ALL MCS Contractors quoting for the project.

The certificate may be provided by one of the prospective MCS Contractors quoting, in which case it must be made available without charge to all other MCS Contractors who are quoting but it is preferred this is provided by the prospective client from an independent surveyor.

The use of multiple EPCs is not permitted. If an MCS Contractor finds another MCS Contractor has not complied with these guidance notes they should bring this to the attention of the prospective client.

Where significant alterations to the building are intended, for example, in an extension or increased insulation, the heat demand from a draft EPC may be used and the EPC 'lodged' when the works are completed. Of course if there is any variation in the final completed works compared to what was included on the draft EPC, a new HPSPE must be submitted to the consumer incorporating such changes.

It is NOT necessary to obtain a new EPC if only the heat source is being changed as the heat demand should remain the same.

Please note:

With current government incentive schemes there can be a significant problem with an application for funding if the EPC heat demand exceeds the MCS predicted heat demand as calculated by the MCS Contractor. This is because the EPC could be considered as being excessive and hence misuse of public funds due to excessive payments. In addition, multiple EPCs with very different heat demand figures, lodged for the same property within a short period of time (e.g. eligibility period of an EPC) could trigger an investigation and suspension of any government incentive monies.

New Build

For new builds the SAP values ("Predicted Energy Assessment") will need to be used. The most up-to-date version of SAP must always be used and assessors are required to check for updates on a weekly basis. SAP 'F' is also acceptable as is any other form of SAP that is used to obtain Building Regulation approval.

Listed buildings

Where listed buildings are not required by law to have an EPC for the purposes of selling or renting, they would need one to apply for RHI. Therefore, it is not unreasonable to require one for an MCS compliant quotation especially when DRHI is intended to be applied for. In the rare case where MCS Certification is being sought for a renewable heating system in a listed building but not RHI, the wording of MIS 3005 would still require an EPC to be provided. This is not deemed to be a major barrier in terms of the cost of the assessment/certificate, compared to the cost of the works and the need for improved consumer protection.

5. Alternative Fuels

The HPSPE attempts to make a like-for-like comparison with the alternative fuels. In the case of new build this comparison would be made with the most likely alternative considered. In the case of an existing building the comparison would be made with the fuel likely to be displaced.

6. System Efficiencies

Existing or Alternative (for New Build):

Gas, LPG & Oil Boilers

The value is provided based on the age of the boiler and represents an operational rather than test value. Although these values are approximate and by nature will be arbitrary, the margin of error is relatively small.

Wood, Pellet

These are used to calculate the amount of fuel.

Coal and Anthracite

These are used to calculate the amount of fuel.

SCoP:

Multiple Heat Pumps (Space Heating)

If multiple heat pumps are proposed to be installed on a project which requires an HPSPE (PET) (i.e. domestic or non-domestic sub 45kW) MCS HPWG 6 require that the SCoP be used for the worst performing (i.e. lowest SCoP) of all the heat pumps installed on the same hydraulically linked heating system.

Hot Water

This may be calculated in accordance with clause 4.3.2.d) of MIS 3005 or alternatively a default value is used of 1.7 for ASHP & 2.24 for GSHP.

7. Who should complete an HPSPE?

MCS HPWG6 determined this should be completed by personnel with technical skills and should not be completed by personnel with only sales or administrative skills. Technical skills could be assessed by Certification Bodies using guidance from the latest version of MCS 025.

The MCS Contractor is responsible for ensuring that personnel filling out HPSPE are suitably competent. The completed HPSPE should also be explained to the consumer by suitably competent personnel who are able to answer typical queries.

8. Under what circumstances do I need to issue a revised HPSPE?

In principle a new HPSPE should be issued whenever something changes in the design or installation that would materially change the HPSPE. The principal changes are:

- Overall heat demand. For example, changes to construction size or design.
- Change in maximum design flow temperature due to change in emitter design.
- Change in fuel price resulting in a significant change to the financial outcome for the consumer such as pay back changes.
- Equipment change. For example, selecting a different heat pump unit to that quoted/previously agreed.
- Change to the system design. For example, switching from a GSHP to an ASHP.

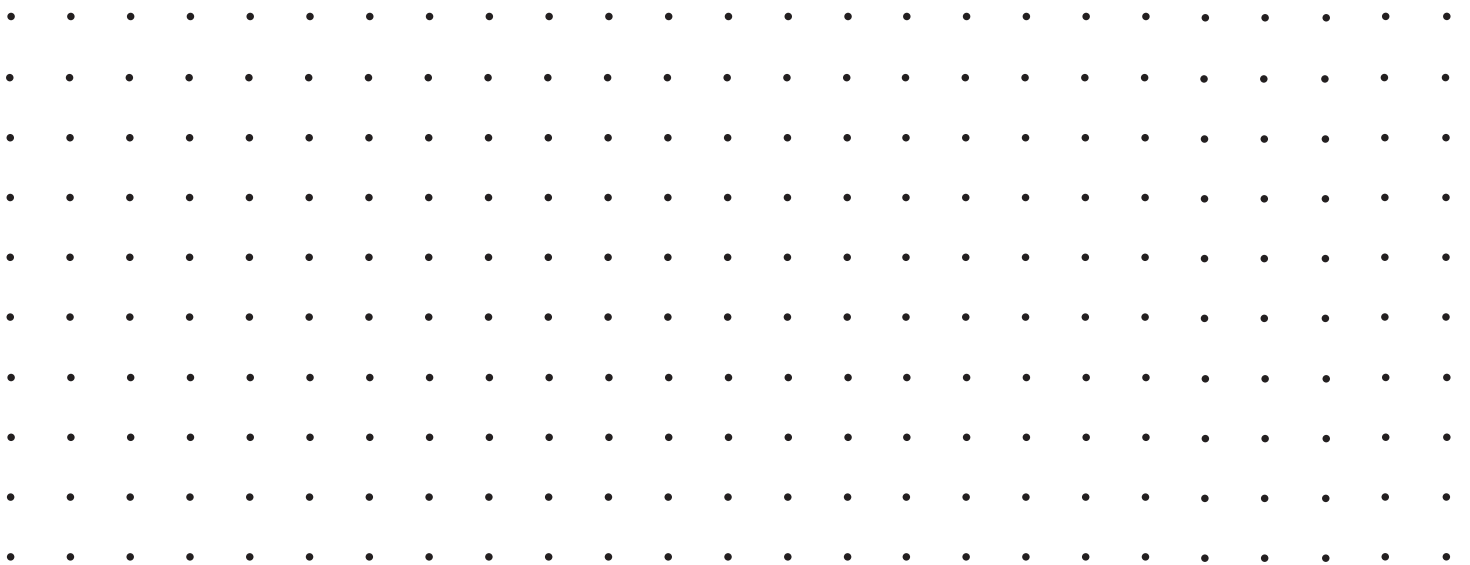

Disclaimer

Any views expressed in this publication are not necessarily those of MCS or its contributory organisations (such as Energy Saving Trust, RECC and HPA) or all individuals representing those organisations. MCS has made every effort to ensure the information and guidance in this publication were accurate at the time of publication, but cannot accept any responsibility for the subsequent use of this information, nor for any error or omissions contained within. To the extent permitted by law, MCS and its contributory organisations shall not accept any liability howsoever arising from reliance on the information or any statement contained herein.

All URLs accessed in January 2018. Any third party URLs are provided for information and reference purposes only and neither MCS nor the contributors to this document, control or warrant the accuracy, relevance, availability, timeliness or completeness of any information contained on such 3rd party websites.